

L-332
Bravura™ Series
(includes Drawknob series instruments)

Copyright © 2015 Allen Organ Company LLC
All Rights Reserved

ALLEN ORGAN COMPANY

For more than sixty years--practically the entire history of electronic organs-- Allen Organ Company has built the finest organs that technology would allow.

In 1939, Allen built and marketed the world's first electronic oscillator organ. The tone generators for this instrument used two hundred forty-four vacuum tubes, contained about five thousand components, and weighed nearly three hundred pounds. Even with all this equipment, the specification included relatively few stops.

By 1959, Allen had replaced vacuum tubes in oscillator organs with transistors. Thousands of transistorized instruments were built, including some of the largest, most sophisticated oscillator organs ever designed.

Only a radical technological breakthrough could improve upon the performance of Allen's oscillator organs. Such a breakthrough came in conjunction with the United States Space Program in the form of highly advanced digital microcircuits. In 1971, Allen produced and sold the world's first musical instrument utilizing digitally sampled voices!

Your organ is significantly advanced since the first generation Allen digital instrument. Organs with Renaissance/Quantum™ technology are the product of years of advancements in digital sound and control techniques by Allen Organ Company. This system represents the apex of digital technology applied to exacting musical tasks. The result is a musical instrument of remarkably advanced tone quality and performance.

Congratulations on the purchase of your new Allen Organ! You have acquired the most advanced electronic organ ever built, one that harnesses a sophisticated custom computer system to create and control beautiful organ sound. Familiarize yourself with the instrument by reading through this booklet.

Contents

I.	ORGAN STOPS.....	1
II.	SPECIALIZED STOP CONTROLS.....	2
III.	EXPRESSION & CRESCENDO SHOES	4
IV.	TUTTI I and TUTTI II.....	4
V.	SETTING CAPTURE REGISTRATIONS.....	4
VI.	ARTISTIC REGISTRATION.....	7
VII.	TRANSPOSER	11
VIII.	ACOUSTIC PORTRAIT™.....	11
IX.	INSTALLATION, VOICING, AND CARE OF THE ORGAN.....	12
X.	SAFETY INFORMATION.....	13
XI.	GENISYS™ CONTROLLER GUIDE	15
	APPENDIX A: MIDI IMPLEMENTATION CHART.....	77
	APPENDIX B: HYMN PLAYER Song List.....	78
	APPENDIX C: GNU PUBLIC LICENSE INFORMATION	79

I. ORGAN STOPS

PITCH FOOTAGE

The number appearing on each stop, along with its name, indicates the “pitch” or “register” of the particular stop. Organs can produce notes of different pitches from a single playing key. When this sound corresponds to the actual pitch of the played key, the stop is referred to as being of 8’ (eight foot) pitch; therefore, when an 8’ stop is selected and Middle C is depressed, the pitch heard is Middle C. If the sounds are an octave higher, it is called 4’ or octave pitch. If two octaves higher, it is called 2’ pitch. A stop sounding three octaves higher is at a 1’ pitch. Similarly, a 16’ stop sounds an octave lower and a 32’ stop two octaves lower.

Stops of 16’, 8’, 4’, 2’ and 1’ pitch all have octave relationships, that is, these whole numbered stops all sound at octaves of whatever key is depressed. Non-octave pitches are also used in organs. Their footage numbers contain a fraction and they are referred to as *Mutations*. Among these are the 2-2/3’ *Nasard*, 1-3/5’ *Tierce*, 1-1/3’ *Quintflöte* and 2-2/3’ *Twelfth*. Because they introduce unusual pitch relationships with respect to the 8’ tone, they are most effective when combined with other stops and used either in solo passages or in small ensembles of flutes.

TONAL FAMILIES

1. Flues

Organ tones divide into two main categories: *flues* and *reeds*. In pipe organs, flue pipes are those in which the sound is set in motion by wind striking directly on the edge of the mouth of the pipe. Flues include principal, flute and string tones. Compound stops and hybrid stops are variations within these three stop families.

The term “imitative” means that the organ stop imitates the sound of a corresponding orchestral instrument; for example, an imitative 8’ Viola stop sounds like an orchestral viola.

<u>Principal Voices</u> Principal, Diapason, Octave, Fifteenth, Quinte	Characteristic organ tones, not imitative of any orchestral instruments. Usually present at many pitches and in all divisions. Rich, warm and harmonically well developed.
<u>Flute Voices - Open:</u> Harmonic Flute, Koppelflöte, flute mutation stops <u>Flute Voices - Stopped:</u> Holzgedackt, Bourdon, Lieblichgedackt, Rohr Bourdon	Lesser harmonic development than Principals. Open flutes are somewhat imitative; stopped flutes are not. Present at all pitch levels and in all divisions.
<u>String Voices</u> Gamba, Salicional, Viole Céleste	Mildly imitative and brighter harmonic development than Principals. Usually appear at 8’ first; can be 4’ & 16’ ranks.
<u>Compound Voices</u> Mixture, Fourniture	Voices produced by more than one rank sounding simultaneously. Best registered with other stops.

<u>Hybrid Voices</u> Erzähler, Spitzflöte	Voices that combine the tonal characteristic of two families of sound, e.g., flutes and principals, or strings and principals.
--	--

2. Reeds

In *reed* pipes, a metal tongue vibrates against an open flattened side of a metal tube called a shallot. The characteristic sounds of different reeds are produced through resonators of different shapes. The family of reeds subdivides as follows:

<u>Chorus or Ensemble:</u> Double Trumpet, Tromba, Posaune, Clarion, Bombarde <u>Solo:</u> Hautbois, Clarinet, Krummhorn	Voices of great harmonic development; some are imitative of their orchestral counterparts.
--	--

Your Allen Organ provides authentic, digitally sampled voices. They are protected by copyrights owned by the Allen Organ Company and are stored in memory devices, each having affixed to it a copyright notice; e.g., © 2003 AOCO, © 2001 AOCO, etc., pursuant to Title 17 of the United States Code, Section 101 et seq.

II. SPECIALIZED STOP CONTROLS

Some organ stop controls do not turn voices on/off, but instead turn on/off console functions such as outlined in this Section.

8' Great to Pedal	Connects all Great stops to the Pedal at unison pitch.
8' Swell to Pedal	Connects all Swell stops to the Pedal at unison pitch.
8' Positiv to Pedal	Connects all Positiv stops to the Pedal at unison pitch.
8' Swell to Great	Intermanual coupler connecting all Swell stops to the Great manual at unison pitch.
8' Positiv to Great	Intermanual coupler connecting all Positiv stops to the Great manual at unison pitch.
8' Swell to Positiv	Intermanual coupler connecting all Swell stops to the Positiv manual at unison pitch.
MIDI on Pedal	Opens MIDI channel to the Pedal.
MIDI on Swell	Opens MIDI channel to the Swell
MIDI on Great	Opens MIDI channel to the Great.
MIDI on Positiv	Opens MIDI channel to the Great.
Tremulant	This stop provides a vibrato effect, natural in the human voice and wind instruments.
Tremulants Full	When activated with one or more of the organ's tremulants, it causes the tremulants to become much deeper than normal classical tremulants. Very useful for Gospel music. Also known as "Vibrato."

Swell Unison Off	Turns off stops only within the Swell Division at unison pitch. Note: Stops coupled into the Swell from other divisions will play from the Swell manual at unison pitch. Also, Swell Division stops coupled to other manuals or the pedalboard will play at unison pitch.
Positiv Unison Off	Turns off stops only within the Positiv Division at unison pitch. Note: Stops coupled into the Positiv from other divisions will play from the Positiv manual at unison pitch. Also, Positiv Division stops coupled to other manuals or the pedalboard will play at unison pitch.
Gt-Pd Unenclosed	When engaged, the Great-Positiv-Pedal expression shoe will only express the Positiv Division. The expression control for the Great/Pedal Divisions is disabled, causing the Great/Pedal stops to sound at full volume, regardless of the position of the Great-Positiv-Pedal expression shoe.
Positiv Unenclosed	When engaged, the Great-Positiv-Pedal expression shoe will only express the Great/Pedal Divisions. The expression control for the Positiv Divisions is disabled, causing the Positiv stops to sound at full volume, regardless of the position of the Great-Positiv-Pedal expression shoe.
Positiv Express w/Swell	When engaged, the Positiv Division will express with the Swell expression shoe.
Melody Coupler (Po>Gt)	When playing on the Great manual, the highest key played on the Great will automatically play all stops drawn on the Positiv, in addition to those drawn on the Great. By choosing a Positiv stop, such as the Festival Trumpet or Krummhorn, the melody played by the top note on the Great is accentuated.
Bass Coupler	Similar to the Melody coupler, however, in this case the lowest note played on the Great will also play all stops drawn in the Pedal Division. This allows voices normally played from the pedalboard to be heard without using the pedalboard.
Alternate Tuning	When activated, the organ's tuning will change to the alternate tuning selected from within the GeniSys™ Controller. See the GeniSys™ Controller Guide, later in this Manual, for more information relating to Alternate Tunings.
Manual Transfer (Gt>Po)	Exchanges stops and divisional pistons between the Great and Positiv Divisions so the stops/divisional pistons from the Great Division are played/accessed from the Positiv Manual and the stops/divisional pistons from the Positiv Division are played/accessed from Great manual.
Swell Mains Off	Used in conjunction with the Swell Antiphonal speaker control. This control turns off the Swell divisional Main speakers. Note: If turned on while the Swell Antiphonal speaker controls are turned off, the organ will not sound.
Swell To Antiphonal	Used in conjunction with the Swell Main speaker control. This control turns on the Swell divisional Antiphonal speakers. Note: If turned off while the Swell Main speaker controls are turned on, the organ will not sound.

- Gt-Po-Pd Mains Off Used in conjunction with the Great, Positiv and Pedal Antiphonal speaker control. This control turns off the Great, Positiv and Pedal divisional Main speakers.
Note: If turned on while the Swell, Great, Positiv and Pedal Antiphonal speaker controls are turned off, the organ will not sound.
- Gt-Po-Pd To Antiphonal Used in conjunction with the Great, Positiv and Pedal Main speaker control. This control turns on the Great, Positiv and Pedal divisional Antiphonal speakers.
Note: If turned off while the Swell, Great, Positiv and Pedal Main speaker controls are turned on, the organ will not sound.

III. EXPRESSION & CRESCENDO SHOES

The organ's control pedals (called "shoes") control expression and crescendo.

- ❑ The left-most shoe expresses the Great, Positiv and Pedal Divisions.
- ❑ The next/middle shoe expresses the Swell Division.
- ❑ The right-most shoe is the Crescendo shoe. It is a master Crescendo for all divisions. It gradually adds stops as it is opened/depressed. Sequential green, yellow and red lights on the organ's bar graph indicator display relative pedal position. Indiscriminate use of the Crescendo, in lieu of careful registration, should be avoided.

The Crescendo B thumb piston is associated with the Crescendo shoe. Crescendo B accesses a second set of Crescendo registrations that can be different from the standard Crescendo registrations. See the GeniSys™ Controller Guide later in this manual for more information relating to changing the registration settings of this secondary Crescendo.

IV. TUTTI I and TUTTI II

The Tutti I and II pistons are sets for full organ registrations. Tutti II has a larger, louder registration, than Tutti I. The Tuttis are turned on and off by pressing manual thumb pistons TUTTI I or TUTTI II. The pistons are "toggled" meaning that pressing them a second time reverses the ON or OFF setting of the corresponding Tutti. Only one Tutti can be turned ON at a time. Pressing the other Tutti piston that is not turned ON will turn OFF the Tutti that was ON and turn ON the Tutti that was OFF. The *Cancel* piston button will turn OFF both the Tuttis.

Red signal lights illuminate when Tutti I or II is in operation. These lights are labeled and located on the Bar Graph Indicator. A second set of Tuttis can be programmed by the organist. Like the Crescendo, indiscriminate use of Tuttis should be avoided. See the GeniSys™ Controller Guide later in this manual for more information relating to changing secondary Tuttis settings.

V. SETTING CAPTURE REGISTRATIONS

Your Allen organ's capture system lets you set stop registration combinations in each of its available capture memories. The L-332 (DK included) has a set of ten (10) General pistons located under the left side of the Swell and Great manuals and six (6) Divisional pistons for each manual division which are centrally located under the Swell, Great and Positiv manuals. There is also a set of six (6) toe studs, located to the right of the organ's Crescendo shoe for the Pedal division. As a convenience to the organist, a set of six (6) General division toe studs are located to the left of the organ's Great-Positiv-Pedal Expression shoe. The General toe studs, when pressed, will activate the same stop registration programmed on the same number General piston.

SETTING GENERAL PISTONS

General pistons will affect all stops in any division. Any stop turned on will be set within a General piston registration. To set a General piston:

- ❑ First, turn on any stops you wish to save within a registration.
- ❑ Press and hold the **SET** Piston.
- ❑ Press and release the desired GENERAL piston.
- ❑ Finally, release the **SET** Piston.

Note: *General pistons are customarily set from soft to loud using graduated stop combinations.*

SETTING DIVISIONAL PISTONS

Divisional pistons are different in that they only affect the stops of a single division. For example, only the Swell stops can be programmed onto a Swell divisional piston. Any Great stops turned on while selecting or setting a Swell divisional piston will be unaffected or changed. To set a Divisional piston:

- ❑ First, only turn on stops within a single division you wish to save within a registration.
- ❑ Press and hold the **SET** Piston.
- ❑ Press and release the desired DIVISIONAL piston.
- ❑ Finally, release the **SET** Piston.

The pistons, General or Divisional, which have been set “remember” the registration combinations which have been assigned to each of them. Each time a given piston is pressed, the registration assigned to it is activated. Stop registration combinations may be changed at any time by repeating the above procedures.

SETTING TOE PISTONS (STUDS)

Stop registration combinations may be set and drawn by toe studs, as well as by pistons. Toe studs, located on each side of the Expression and Crescendo shoes, are set in the same manner as thumb pistons. The toe studs on the left are duplicates of General pistons. The toe studs on the right are Pedal Divisional toe studs.

To set a Pedal Divisional Toe Stud...

- ❑ Select the desired Pedal stops.
- ❑ Hold the SET button, and momentarily press the desired Pedal toe stud.
- ❑ Finally, release the SET button.

When you set a General Piston, that combination is set automatically on the toe stud of the same number. That is, setting General Piston #8 also places its combination on General toe stud #8.

RECALL “R” PISTON

The “R” or Recall piston recalls the last registration setting prior to using any General or Divisional piston. For example;

- ❑ Press a General or Divisional piston/toe stud. The stop registration programmed on that particular piston/toe stud will appear.
- ❑ Manually register additional stops to the current stop registration.
- ❑ Now, press a different General or Divisional piston/toe stud. The stop registration programmed on that particular piston/toe stud will appear.
- ❑ Press the “R” piston. The previous stop registration, including those stops registered manually, will re-appear.

What happens is that the capture system takes a “snapshot” of the current stop registration and stores it within the Recall piston memory before it actually changes to the new stop registration selected. Then, when the “R” piston is pressed, the capture system “recalls” the previous registration stored before the last piston/toe stud selection was made.

REVERISBLE PISTONS

The L-332 and L-332DK console contains several reversible type piston buttons. Reversible pistons are those which “toggle” a specific stop on or off when pressed. If a stop assigned to a reversible piston is on, pressing the associated reversible piston will turn the stop off. The same is true in reverse, if the stop is off, pressing the associated reversible piston will turn the stop on.

VI. ARTISTIC REGISTRATION

(Trained organists might not need to review this section.)

Organ registrations fall into two broad categories; *solo combinations* and *ensembles*. A solo combination is one in which a melody is played on one keyboard, the accompaniment on another keyboard. The pedal often provides a light bass line. Almost any stop or combination of stops will sound good as a solo voice. A contrasting tone quality should be chosen for the accompaniment, so that the accompaniment is softer than the solo voice. The Pedal stops must provide a foundation for the solo and accompaniment without covering them.

Most 8' reed stops make interesting solo voices. The addition of a 4' flute or a flute mutation (e.g., Nasard or Tierce) to a reed such as the Trompette colors the sound further and increases its volume slightly. Adding an 8' flute to a reed adds body to the sound.

Flutes can be used alone or in combinations as solo voices. One special combination of flutes that creates an appealing and historically significant solo combination is the Cornet (pronounced kor-NAY). The Cornet is created by using the following Swell stops: Rohr Bourdon 8', Traverse Flute 4', Nasard 2-2/3', Piccolo 2' and Tierce 1-3/5'. This solo combination, widely used for Baroque organ music, is just as appropriate for some modern music. Useful variations of the Cornet may be achieved by eliminating the 4', the 2', or even both.

When choosing stops for a solo voice, it is not always necessary to include an 8' stop; for example, since the 4' flute has a tone quality different from that of the 8' flute, the 4' flute can be used as an independent solo voice. By playing a solo voice an octave lower than written, the notes sound at the correct pitch. In similar fashion, a 16' stop can be selected and the notes played an octave higher than written. Tonal variety is gained, because each stop has its own tone color.

For accompaniment, the most desirable voices are the 8' flutes or strings on each manual. Celestes often make effective accompaniments. The correct choice depends on the volume of the solo tone (a soft solo voice requires the softest accompaniment stop), the element of contrast, and the location of the solo stop. A bright, harmonically rich solo reed, for example, can be accompanied by either a string or flute, though the flute often contributes greater interest because of its greater contrast. Try to seek a "natural" balance of volume between solo and accompaniment.

SUGGESTED SOLO REGISTRATIONS

CHIMES SOLO

Swell: Rohr Bourdon 8' or Viole 8', Viole Celeste 8'

Great: Chimes

Positiv: Holz Gedackt 8', Swell to Choir 8'

Pedal: Bourdon Doux (Sw) 16', Swell to Pedal 8'

Play solo on Great and accompaniment on Swell or Choir

SOLO CORNET COMBINATION

Swell: Rohr Bourdon 8', Flute 4', Nasard 2-2/3', Octavin 2', Tierce 1-3/5'

Great: Viole 8'

Positiv: Holz Gedackt 8'

Pedal: Bourdon Doux 16', Gedackt 8'

Play solo melody on Swell and accompaniment on Great or Choir.

TRUMPET SOLO

Swell: Trompette 8

Great: Principal 8', Viole 8', Octave 4', Positiv to Great 8'

Positiv: Holz Gedackt 8, Prinzipal 4

Pedal: Contre Violone 32', Principal 16', Octave 8', Positiv to Pedal 8'

Play melody on Swell and accompaniment on Great.

These few combinations demonstrate basic techniques of solo registration. In creating registrations of your own, remember these three simple rules:

- ❑ Seek tonal contrast between solo and accompaniment.
- ❑ Be sure the solo is louder than the accompaniment.
- ❑ Choose a solo whose character is appropriate to the specific piece.

ENSEMBLE REGISTRATIONS

Volumes have been written on the subject of ensemble registration. Following is a summary of the major points.

- Ensemble registrations involve groups of stops that are played together, usually, but not always, with both hands on one keyboard. They are characterized by compatibility of tone, clarity, and occasionally power. Such registrations are used in hymn singing, choir accompaniments, and much of the contrapuntal organ literature.
- Two factors are always to be considered: tone quality and pitch. Ensembles begin with a few stops at the 8' and/or 4' pitch and expand "outward" in pitch as they build up. New pitches are usually added in preference to another 8' stop. Ensembles are generally divided into three tonal groupings called "choruses":

The Principal Chorus is the most fully developed with representation in various divisions of the organ and at every pitch from 16' to high mixtures. The Principal Chorus is sometimes called the narrow-scale flue chorus, a reference to the relative thinness of Principal pipes in relation to their length.

The Flute Chorus is also well represented with a diversity of stops at various pitches. Generally speaking, the Flute Chorus is composed of less harmonically developed tones, and is smoother and of lesser volume than the Principal Chorus. The Flute Chorus is sometimes called the wide-scale flue chorus, owing to the generally "fatter" look of Flute pipes as compared to Principals.

The Reed Chorus includes those reed tones designed to be used in the ensemble buildup. Not all reed voices are ensemble tones. A Clarinet, for example, is usually a solo stop. The various Trumpets, Clairons, Bassons, etc., are usually ensemble voices that add brilliance, power, and incisiveness to the sound. If you have questions as to whether a specific reed is a solo or ensemble stop, refer to the stop list in the preceding section.

The Swell Reed Chorus is a special ensemble of Basson 16' and Trompette 8'. It represents an entity important to French organ music and the full ensemble of the organ. These stops create a "blaze" of richly harmonic sounds that tops off both flue choruses.

Another special ensemble combination important in French music is the **Cornet** (described in the section on Solo Registration). This combination can be used with the chorus reeds and mutations to create the "Grand Jeu." The Cornet is also useful in Romantic ensembles, adding weight and thickness to the sound.

SUGGESTED ENSEMBLE COMBINATION REGISTRATIONS:

GREAT ENSEMBLE COMBINATIONS

1. Harmonic Flute 8', Spire Flute 4'
2. Harmonic Flute 8', Spire Flute 4', Fifteenth 2'
3. Principal 8', Octave 4'
4. Principal 8', Octave 4', Fifteenth 2'
5. Principal 8', Octave 4', Fifteenth 2', Mixture IV
6. Principal 8', Harmonic Flute 8', Octave 4', Spire Flute 4', Fifteenth 2', Mixture IV

SWELL ENSEMBLE COMBINATIONS

1. Rohr Bourdon 8', Viole 8'
2. Rohr Bourdon 8', Viole 8' Flute 4'
3. Rohr Bourdon 8', Viole 8' Flute 4', Octavin 2'
4. Rohr Bourdon 8', Viole 8' Flute 4', Octavin 2'
5. Rohr Bourdon 8', Viole 8' Flute 4', Octavin 2', Plein-Jeu IV
6. Rohr Bourdon 8', Viole 8' Flute 4', Octavin 2', Plein-Jeu IV, Trompette 8'

POSITIV ENSEMBLE COMBINATIONS

1. Holzgedackt 8', Prinzipal 4'
2. Holzgedackt 8', Koppelflöte 4'
3. Holzgedackt 8', Koppelflöte 4', Prinzipal 4'
4. Holzgedackt 8', Koppelflöte 4', Prinzipal 4', Oktav 2'
5. Holzgedackt 8', Koppelflöte 4', Prinzipal 4', Oktav 2', Mixture III

The use of the Swell to Great and Positiv to Great coupler allows these separate ensembles to be combined on the Great manual. It is also possible to combine some of these ensembles within the same division; for example, when the #5 Great and #3 Swell registrations are coupled together and played on the Great, they combine to form a nice round hymn combination.

The Pedal ensemble is created in much the same way as the manual ensembles, starting at 16' pitch instead of 8'. Be careful that the volume of the pedals is not greater than that of the manuals. Although the manual to pedal couplers are useful in bringing clarity to the pedal line, especially on softer registrations, avoid the temptation to rely constantly on one or two 16' stops and a coupler. Please note that the softest stops and flute mutations are normally not used with ensembles.

FULL ORGAN

Due to the immense capabilities of the organ, every stop and coupler on the instrument could be used simultaneously without distortion, if the organ is adjusted properly. In good registration practice, however, the organist would not haphazardly put on every stop on the instrument. For best results, listen and include only those stops that really contribute to the fullness and brilliance of the ensemble. Eliminate soft stops and solo stops that make no purposeful contribution.

This short treatment barely scratches the surface of the fascinating subject of organ registration. For those interested in gaining further insight into this vital area of organ playing, we recommend the following texts:

- Audsley, George Ashdown. *Organ Stops and their Artistic Registration*.
Hialeah, FL: C.P.P. Belwin, 1985.
- Irwin, Stevens. *Dictionary of Pipe Organ Stops*. 2nd ed.
New York: Macmillan Books, 1983.

VII. TRANSPOSER

Vast computer capability makes it possible to perform the sometimes difficult task of transposing, while allowing the organist to play in the notated key. The GeniSys™ Controller controls the operation of the Transposer. The GeniSys™ Controller is located at the left side of the console.

Transposition to any of the twelve musical keys is possible. When the organ's power is first turned ON, the GeniSys™ Controller window displays a brief message then displays M 1, indicating the first capture memory level. Also displayed is the Transposer setting of neutral pitch. The Transposer is displayed as a large digit within the GeniSys™ Controller display (“0” is displayed on the right side of the display).

To shift the music to a higher key, you must first move the cursor's position in the GeniSys™ Controller's display window so that the “0” symbol is selected. To move the cursor, repeatedly press the button on the GeniSys™ Controller labeled "CURSOR" until the “0” symbol is selected. Once the “0” symbol is selected, turn the GeniSys™ Controller's Rotary Dial to select the new musical key. Turning the dial in a clockwise manner selects higher keys and causes the organ's pitch to rise. Turning the dial in a counter-clockwise manner selects a lower key and causes the organ's pitch to go lower. The pitch can be raised a maximum of five half-steps or lowered a total of seven half-steps. Be aware that the Transposer's range settings "wrap around" from the plus five half-step setting to the minus seven half-step setting.

A red indicator light (LED) on the face of the GeniSys™ Controller illuminates any time the Transposer setting is moved from the “0” or neutral pitch position.

Why Transpose?

- ❑ Because a song's range does not always suit the vocal range of a particular singer. By adjusting the Transposer, the piece can be sung more comfortably and effectively.
- ❑ Because some instruments are non-concert pitch. A trumpet in B^b , for example, can play the same music as the organist, if the Transposer knob is set two half steps lower.
- ❑ Because hymn singing can sometimes be improved by a more favorable key selection.

VIII. ACOUSTIC PORTRAIT™

Allen Organs are the only digital organs to bring the science of sampling to acoustics! Ordinary electronic reverb is a synthetic imitation of acoustics “applied to” the sound, not created as an integral part of it. Acoustic Portrait™ produces the real thing in exacting detail!

Acoustic Portrait™ begins with a sampling process using impulse responses that measure an actual room's acoustic properties. These measurements are then stored in the organ's computer memory. Through an advanced real-time mathematical process called “convolution”, the acoustics of the sampled room actually become an integral part of the organ's sound, producing a noticeably smoother, more natural result than synthetic reverb. Allen engineers have recorded the acoustics of cathedrals and other acoustically desirable buildings throughout the world. With advanced processors (DSP) and patented low-latency convolution algorithms, Acoustic Portrait™ reproduces the true acoustic response of each original room with stunning realism! Each organ equipped with Acoustic Portrait™ features 10 different Acoustic Portrait pallets, ranging from intimate rooms to cavernous cathedrals.

The switch labeled ACOUSTICS on the GeniSys™ Controller must be ON to hear the selected pallet. The selected Acoustic Portrait™ gain, measured in dB (decibels), can be accessed and adjusted within the GeniSys™ Controller. See the GeniSys™ Controller guide later in this manual for more detailed instructions on Acoustic Portrait™ settings and adjustments.

IX. INSTALLATION, VOICING, AND CARE OF THE ORGAN

INSTALLATION

Wherever your organ may be situated, careful installation is a prerequisite to successful results. Your Allen representative is well qualified to guide you in planning the finest possible installation. Factory assistance in planning the installation is also available and may, in fact, be sought by your Allen Organ representative.

VOICING

Your organ presents unprecedented accuracy in the scaling and voicing of each note of every stop. Should any parameters be required to be changed, your Allen Organ representative is able to make such changes. Final adjustments in scaling and voicing involve procedures that are best left to an expert. These adjustments are normally part of the installation, and once completed, should not require changes. If the organ is moved to a new location or major changes are made to the acoustical properties of the room the organ resides in, the instrument may need to be tonally finished again.

CARE OF THE ORGAN

Your Allen Organ constitutes a major advance in long-term maintenance-free operation. There is no regular maintenance procedures required and, therefore, no periodic maintenance schedules to be observed.

Reasonable care will keep the instrument looking beautiful for years to come. The wood surfaces may be cleaned using a soft cloth dampened with lukewarm water. A mild solution of lukewarm water and dish detergent may be used to remove fingerprints, etc. Polish dry with a soft cloth. Do not use wax, sprays or oils on the finish. Satin finished surfaces will take on a semi-gloss appearance when waxed and will eventually become yellowed.

Keys and stop tablets should be cleaned in the following manner: Use two clean cloths. Immerse one in clear, lukewarm water and wring it thoroughly damp dry. Loosen the dirt with this cloth, and then polish immediately with the dry cloth. Do not use soap or detergent on keys or stop tablets.

To polish the clear music rack, a furniture wax polish may be sprayed on a soft dry cloth and rubbed on the front of the music rack. Keep the wax off of the wood finishes. This will help keep the music rack clear.

You have purchased a remarkable organ that not only faithfully reproduces the organ traditions of the past but also anticipates the innovations of the future. Should you have questions that are not addressed in this manual, please do not hesitate to contact your local Allen Organ representative. Welcome to the family of satisfied Allen Organ owners!

X. SAFETY INFORMATION

USA ONLY

CAUTION

Never plug the instrument into any current source other than 110 to 120 volts, 50/60 Hertz alternating current (AC). A verified grounded outlet is essential to proper operation and protection of the instrument. Proper polarity should be checked with an AC circuit analyzer before connecting the organ.

Do not change the cable plug or remove the ground pin or connect with a two-pole ground lift adapter.

If you are in doubt about your electrical connection, consult your local electrician or power company.

In facilities where circuit breakers are turned off between uses (as for example, between worship services), the circuit breaker affecting the organ console AC power should have a guard installed to prevent it from accidentally being switched off.

It is important that you read and comply with all instructions and labels that might be attached to the instrument.

INTERNATIONAL ONLY

CAUTION

Do not plug the instrument into any current source other than that stated by the selling dealer. Proper polarity should be checked with an AC circuit analyzer before connecting the organ.

Do not change the cable plug or remove the ground pin (if applicable).

If you are in doubt about your electrical connection, consult your local electrician or power company.

In facilities where circuit breakers are turned off between uses (as for example, between worship services), the circuit breaker affecting the organ console AC power should have a guard installed to prevent its being accidentally switched off.

Read and comply with all instructions and labels that may be attached to the instrument.

Warning: This equipment generates, uses, and can radiate radio frequency energy and, if not installed and used in accordance with the instruction manual, may cause interference to radio communications. It has been type tested and found to comply with the limits for a Class B Computing Device in accordance with the specifications in Subpart J of Part 15 of FCC Rules, which are designed to provide reasonable protection against such interference in a residential installation. Should this equipment cause interference to radio communications, the user at his own expense will be required to take whatever measures may be necessary to correct the interference. Whether this equipment actually causes the interference to radio communications can be determined by turning the equipment off and on. The user is encouraged to attempt to correct the interference by one or more of the following measures:

Reorient the receiving antenna.

Relocate the organ with respect to the receiver.

Move the organ away from the receiver.

Plug the organ into a different electrical outlet, so that the organ and receiver are on different branch circuits.

If necessary, the user should consult the dealer or an experienced radio technician for additional suggestions.

CE mark shows compliance with the EMC Directive.

XI. GENISYS™ CONTROLLER GUIDE

A.	BASIC OPERATION	16
1.	Start-Up Sequence	16
2.	Advancing Through the Windows.....	17
3.	Selecting the Capture Memories.....	17
4.	Saving Registrations Using the Pistons/Toe Studs	18
5.	Locking Capture Memories	18
6.	Unlocking Memories Using Your Code.....	19
7.	Unlocking All Memories If You Forget Your Code.....	19
8.	Stop Action and Capture Self Check.....	20
9.	Stoplist Library™ (<i>optional</i>).....	20
10.	Acoustic Portrait™ Settings.....	21
11.	Hymn Player	24
B.	USB OPERATION	25
1.	USB Memory Port	25
2.	GeniSys™ Sequencer	26
3.	Capture Memory Registration Save/Load.....	38
C.	ADVANCED OPERATION	43
1.	Selecting an Alternate Tuning	43
2.	Configuring General Pistons	44
3.	Restoring Original Factory Settings	45
4.	Global Tuning.....	46
5.	Headphone Volume (<i>optional</i>).....	46
6.	Modifying the Crescendo and Tuttis	47
7.	Sostenuto (<i>optional</i>).....	50
8.	Piston Sequencer.....	51
C.	MIDI FUNCTIONS	62
1.	Standard MIDI Channel Assignments.....	62
2.	Selecting Program Change Modes	62
3.	General MIDI Sound Names or Program Numbers	63
4.	Assigning MIDI Program Changes to Organ Pistons	66
5.	MIDI Bank Selecting.....	67
6.	Changing the MIDI Base Channel.....	69
7.	MIDI Expression Settings.....	69
8.	MIDI Sustain Kick Switch (<i>optional</i>)	70
9.	Organ Local Off.....	71
10.	Transmission/Reception of Individual Stop Data	72
D.	MIDI GUIDE	73
1.	MIDI for Organists	73
2.	Allen's Exclusive MIDI System.....	74
3.	MIDI Transmission Channels.....	75
4.	GENERAL MIDI SOUND SET.....	76

INTRODUCTION

The GeniSys™ Controller is an interface that controls many organ functions and a variety of MIDI functions. The GeniSys™ Controller includes a LCD (liquid crystal display) window that displays functions, one at a time, as well as an integrated Rotary Dial with push buttons used to make selections. Each window function is described in detail.

A. BASIC OPERATION

1. Start-Up Sequence

Turn on the organ's main power switch. During the start-up sequence, the LCD window will display:

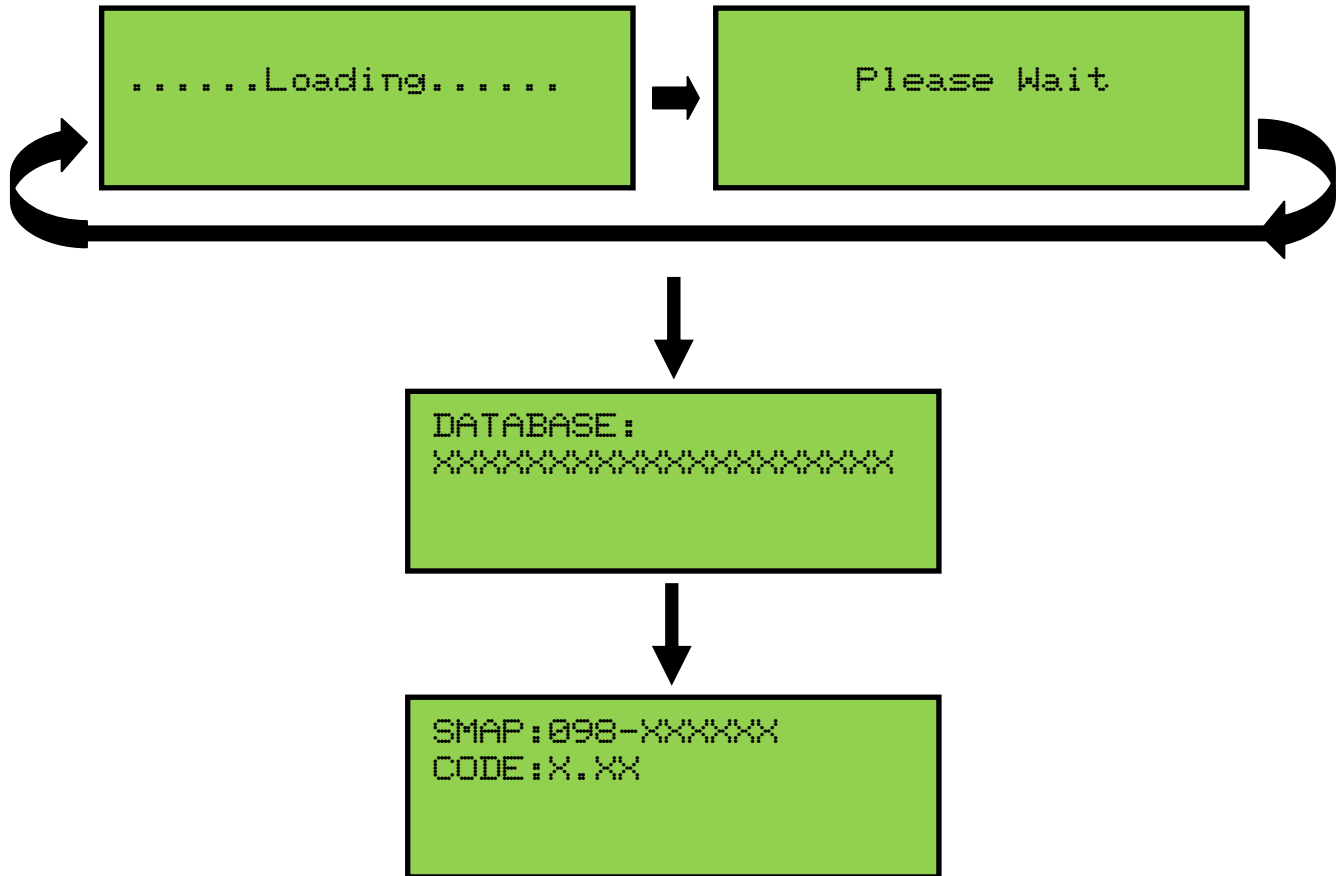

Once the GeniSys™ computer has completed its initial start-up procedure, the LCD will display the current stopmap level (SMAP) and operating software base code level (CODE) currently installed in the organ.

Then, the *Main Window* function is displayed:



Important: The Allen Organ includes several self-testing features. If a warning is displayed within this sequence, please contact your Allen authorized representative immediately!

2. Advancing Through the Windows

The Allen Organ GeniSys™ operating software contains many settings that are user-programmable. Each programmable setting can be adjusted via the GeniSys™ Controller. These programmable settings are divided up into many window functions. To advance the GeniSys™ Controller's display to the next window function, locate and press the **CURSOR** button until the **CURSOR** is positioned under the abbreviation "M" within the display, this location is known as the "Menu Function". Once the cursor is positioned, slowly turn the **ROTARY DIAL** clockwise, the display will advance to the next window function. When the second window function is displayed, rotate the **ROTARY DIAL** counter-clockwise, the window will return to the Main window display function. Turn the **ROTARY DIAL** counter-clockwise again and the last window function will display. The window functions "wrap around" for ease of accessing functions quickly.



or



Remember: You may return to the *Main Window* function at any time by pressing and holding the **SET** piston. Then, while holding **SET**, press the **CANCEL** piston, release both pistons. This procedure will always return the Console Controller's display to the Main Window function.

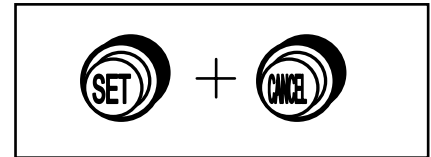

For reference, the last window function is:



3. Selecting the Capture Memories

Locate the **CURSOR** button on the GeniSys™ Controller. Press this button to move the cursor to the number to the right of the abbreviation "M" on the display. Once the cursor is positioned on the memory number, turn the **ROTARY DIAL** clockwise to select the memories sequentially from **M 1, to M 2, to M 3**. Or, turn the **ROTARY DIAL** counter-clockwise to select the memories sequentially from **M 1, to M 40, to M 39, M 38...**



The capture memories allow you to save different registrations on each piston/toe piston. This means **General Piston 1** on **M 1** may be totally different from **General Piston 1** on **M 2, M 3, etc.**

4. Saving Registrations Using the Pistons/Toe Studs

A **registration** is any combination of stops. These registrations can be stored (remembered) by the organ's capture memory system. The pistons provide a way to make changes quickly from one registration to another.

General Pistons are those that affect all stops on the organ. General pistons are located on the left side, underneath the keyboards on the piston rails.

Divisional Pistons affect only those stops associated with the particular manual/division. Divisional pistons are located in the center of the piston rails below the keyboards.

Located just above the pedalboard are the **Toe Studs**. Toe Studs to the left of the expression shoes duplicate the General Pistons, while those to the right of the expression shoes are for the Pedal Division.

The L-332 (DK included) is equipped with ten (10) General pistons, (6) Divisional pistons for the Swell, Great and Positiv Divisions and six (6) Divisional toe studs for the Pedal Division. In addition, there are also six (6) General toe studs which are duplicates of the last six General pistons (5 thru 10).

To Save a Registration to a General Piston:

The *Main Window* function in the GeniSys™ Controller must be displayed (See Section A-2). Select any memory number (M 1, M 2 ... M 40, etc.)(see section A-3); however, for this example use M 1. Next, select the desired stops you want General Piston 1 to remember. Once the selected stops are selected, press and hold the **SET** piston, then press and release General Piston 1. Finally, release the **SET** piston. General Piston 1 will now store in memory the selected stops.

Note: *General Pistons are often set gradually from soft to loud with General #1 the softest and General #10 the loudest.*

To Save a Registration to a Divisional Piston:

The *Main Window* function in the GeniSys™ Controller must be displayed (See Section A-2). Select any memory number (M 1, M 2 ... M 40, etc.)(see section A-3); however, for this example use M 1. Next, select the desired Swell division stops you want Swell Piston #1 to remember. Once the selected stops are selected, press and hold the **SET** piston, then press and release Swell Piston #1. Finally, release the **SET** piston. Swell Piston #1 will now store in memory the selected Swell division stops.

5. Locking Capture Memories

All memories, except Memory 1, may be locked or unlocked individually to prevent unintentional or unauthorized changes to that memory's contents.

Note: Memory 1 remains unlocked as a convenience to visiting or substitute organists (*if applicable*).

The GeniSys™ Controller must display the *Main Window* function (See Section A-2). Select a capture memory to lock. After registrations are stored to pistons, (See Section A-4) choose three digits you can easily remember (e.g., 1-2-3, 2-1-5, etc.). General Piston numbers reflect their respective digits listed on the piston (Piston 10 = zero).



On the GeniSys™ Controller, locate the **MEMORY** button. Press and hold the **MEMORY** button. Then, while holding **MEMORY**, press the General Pistons that will correspond to your three-digit code. Release the **MEMORY** button and an "L" will appear next to the "M" number in the display, indicating this memory is now locked. As long as the memory remains locked, the



piston registrations on that memory cannot be changed. Other organisms will still be able to use the locked registrations; however they cannot be changed. Remember; choose an easy to remember three-digit code.

Note: Each capture memory level lock code can be different!

6. Unlocking Memories Using Your Code

The *Main Window* function must be displayed (See Section A-2). To unlock a memory, select the capture memory to be unlocked. Remember, locked capture memories will have an "L" behind the number. Once a



desired capture memory is selected, press and hold the **MEMORY** button in the GeniSys™ Controller. Then, while pressing **MEMORY**, enter the same three-digit code that was used to lock this memory (See Section A-5). Release the **MEMORY** button. If the correct

code was entered, the "L" will disappear, indicating that this memory is now unlocked.

7. Unlocking All Memories If You Forget Your Code

Advance to the 'UNLOCK ALL CAPTURE MEMORIES' window function (see section A-2).

Press and hold the **MEMORY** button on the GeniSys™ Controller, then press General Pistons 2-5-5, in sequence. Release the **MEMORY** button. The display will automatically return to the *Main Window* function. All capture memories are now unlocked, including those memories other organisms may have locked, however, registrations remain unchanged. The display will return to the *Main Window* function when completed.

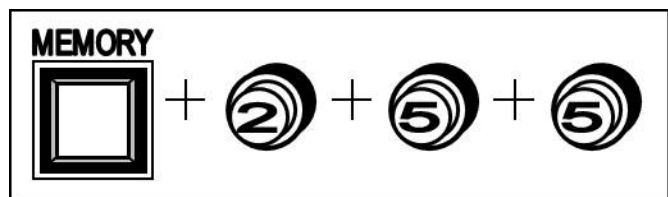

8. Stop Action and Capture Self Check

This feature self-checks the capture system. The test insures each stop is functioning properly and is controllable by the capture system.

Advance to the 'SELF CHECK' window function (*see Section A-2*).



To start the self-check, press the **CURSOR** button on the GeniSys™ Controller to position the cursor on the word "OFF". Turn the **ROTARY DIAL** to start the Self Check function. The display will indicate that the Self Check function is now "ON". The stops will turn on and off consecutively one at a time. *If any stop position does not light (or move if mechanical drawknobs), notify your Allen service technician.*

During the testing process you can interrupt and/or return to the *Main Window* function at any time by turning the **ROTARY DIAL** until "OFF" appears in the display or by using the **SET** and **CANCEL** pistons to return to the *Main Window* function (*see Section A-2*).

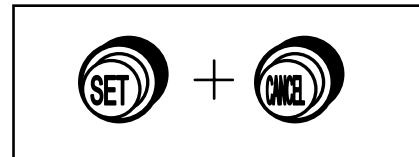
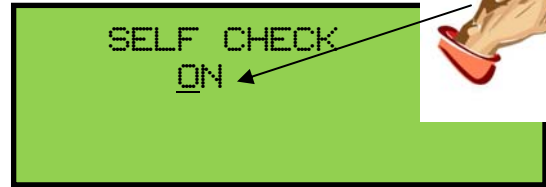
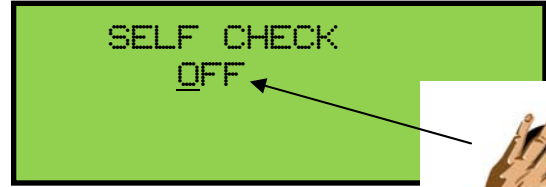

9. Stoplister Library™ (optional)

The L-332 (DK included) can be equipped to include nine complete voicing specifications. A new voicing specification can be selected from the GeniSys™ Controller at any time. To change a voicing specification, advance to the 'STOPLIST LIBRARY™' window function (*see Section A-2*). The display will indicate the current voicing specification loaded.



To change to a different voicing specification, press the **CURSOR** button on the GeniSys™ Controller and position the cursor on the voicing specification name. Turn the **ROTARY DIAL** to select a different voicing specification.

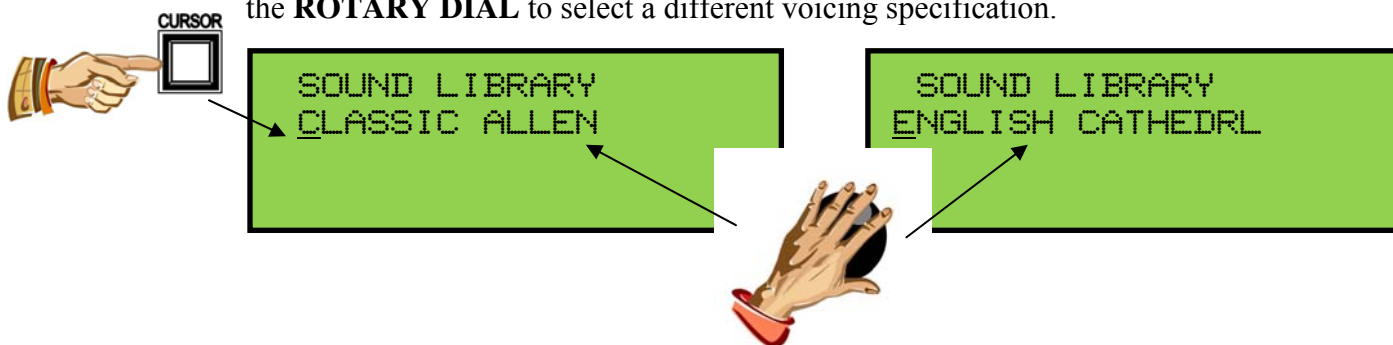

When the desired voicing specification is displayed, press and hold the **SET** piston. Then, while holding **SET**, press the **MEMORY** button on the GeniSys™ Controller. Release both.

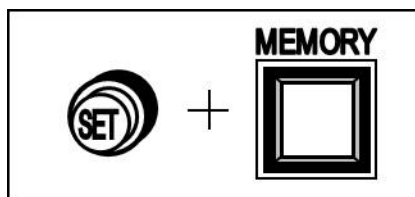

The display will indicate the selected specification is loading. Once the new specification is loaded the capture system will automatically cancel all stops. The organ is now ready to play.

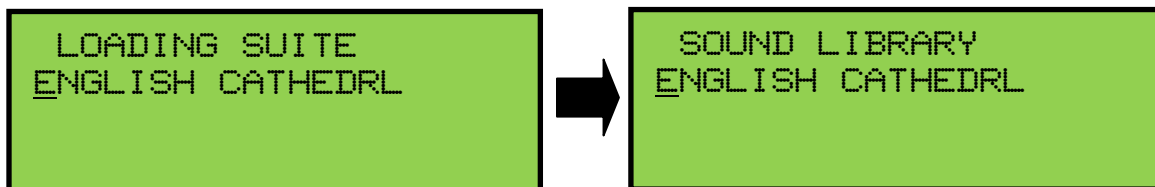

To return to the *Main Window* function, press and hold the **SET** piston then press the **CANCEL** piston. Release both.

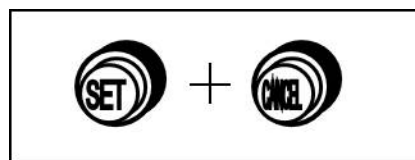

Important: The organ will not be able to be played while a new voicing specification is loading.

10. Acoustic Portrait™ Settings

There are 10 available Acoustic Portrait™ pallets to select from. The rocker switch labeled **ACOUSTICS™** on the GeniSys™ Controller must be switched ON to hear the Acoustic Portrait™ selection. The Acoustic Portrait™ gain (volume) can be adjusted. The gain is indicated dB (decibels). The Acoustic Portrait™ gain range is adjustable from +6dB to minus 35dB. Minus 35dB is the least amount of gain while +6dB is the most available.

ACOUSTICS



in

To change the active Acoustic Portrait™ or adjust the Acoustic Portrait™ gain, advance to the 'ACOUSTIC PORTRAIT™' window function (*see Section A-2*). The window will display the name of the currently selected Acoustic Portrait™ pallet on line 1 with the Gain setting on line 2.

```
Large Room 1
_ Gain = -6 dB
```

To change the Acoustic Portrait pallet, press the **CURSOR** button on the GeniSys™ Controller until the cursor is positioned on the Acoustic Portrait pallet name. Turn the **ROTARY DIAL** on the GeniSys™ Controller to select a different pallet name.

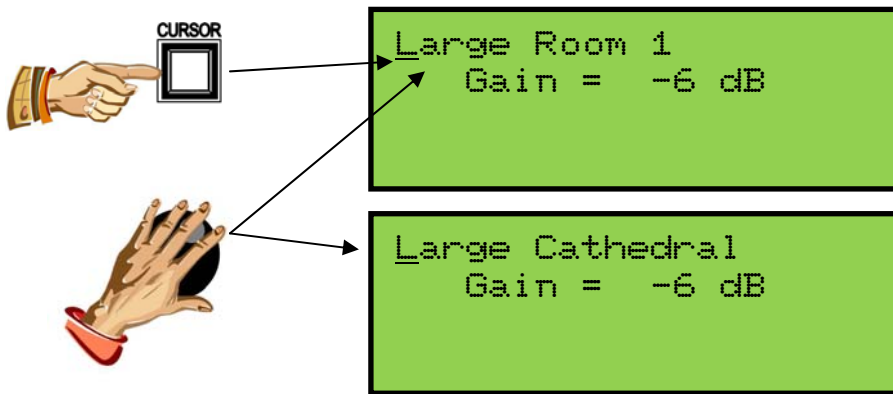

Note: The change will not be immediate. You must wait 3 seconds for the newly selected Acoustic Portrait pallet to load. The display will indicate that the newly selected pallet is loading:

```
Loading Portrait
Gain = -6 dB
```



```
Large Cathedral
Gain = -6 dB
```

Acoustic Portrait Gain (Volume) Adjustment:

To change the Acoustic Portrait Gain setting, press the **CURSOR** button on the GeniSys™ Controller until the cursor is positioned on the Acoustic Portrait gain setting. Turn the **ROTARY DIAL** on the GeniSys™ Controller to change the gain setting. Gain adjustment range is from minus 35dB to +6dB. Minus 35dB is the least amount of gain while +6dB is the most or maximum amount of gain.

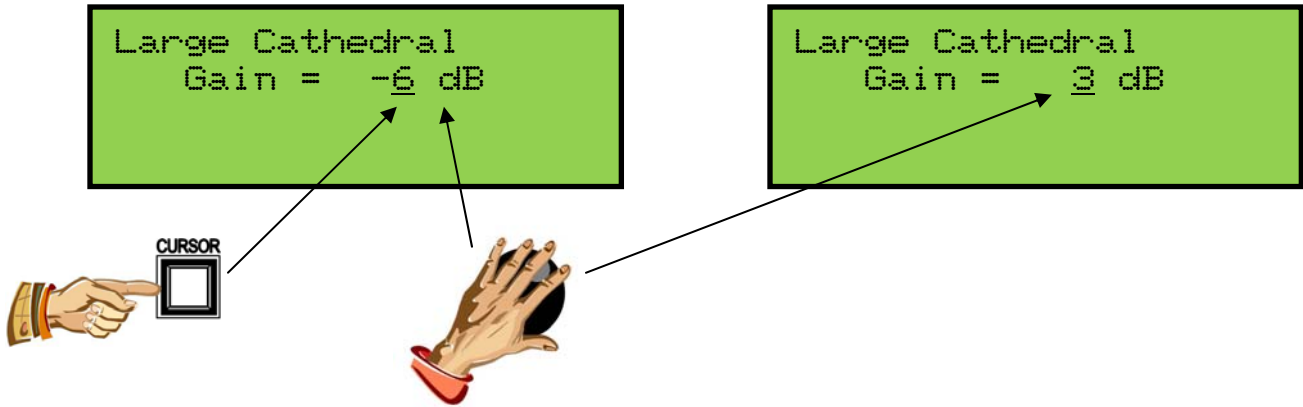

Acoustic Portrait™: Available Reverb Pallets

1. Pipe Chamber
2. Small Theatre
3. Small Church
4. Medium Room 1
5. Medium Room 2
6. Medium Room 3
7. Large Room 1
8. Large Room 2
9. Cathedral
10. Large Cathedral

11. Hymn Player

GeniSys™ instruments contain an internal Hymn Player which plays a selected set of pre-recorded hymns within memory.

Note: Additional hymns cannot be added to the existing list of available hymn selections.

To access the Hymn Player function, advance to the Hymn Player function window (*see Section A-2*).

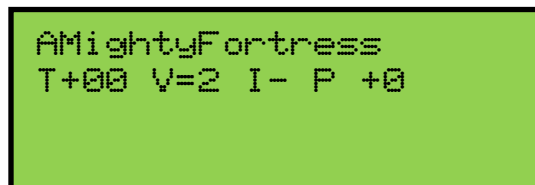

Line 1 of the display indicates the hymn song title and line 2 contains several playback parameters which the organist can adjust. To select a hymn, press the **CURSOR** button to position the cursor on the hymn song title. Then, turn the **ROTARY DIAL** to select a different hymn selection (*Hymns are arranged in alphabetical order*).



Playback Parameters:

To change the value of any of the playback parameters, press the **CURSOR** button to position the cursor on any of the playback parameter values and adjust accordingly.

Tempo: Increase or decrease tempo by positioning the cursor on the Tempo value and then turn the Rotary Dial. Tempo may be adjusted up or down in increments of 10. Maximum tempo value is plus/minus 50.

Verses: Change the number of verses by positioning the cursor on the Verse value and then turn the Rotary Dial. Maximum number of verses is 9.

Introduction: Position the cursor on the Introduction value and then turn the Rotary Dial to select (+) for yes, or (—) for no introduction.

Pitch: Raise or lower the pitch by positioning the cursor on the Pitch value and then turn the Rotary Dial. Pitch may be raised or lowered in half-step increments. Standard Transposer range is applicable; pitch can be raised a maximum of five half-steps or lowered a minimum of seven half-steps.

To begin hymn playback, press the **MEMORY** button. The display will indicate the current verse number playing.

Both the Tempo and number of Verses may be adjusted while the hymn is playing. Press the **CURSOR** button to position the cursor on either the Tempo or Verse value. Then, turn the Rotary Dial to change the value.

To stop hymn playback at any time, press the **CANCEL** piston.

To return to the *Main Window* function, press and hold the **SET** piston. Then, while holding **SET**, press the **CANCEL** piston. Release both.

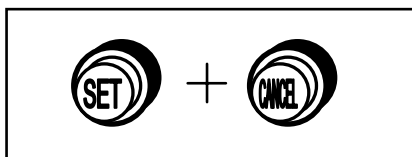

Note: You can change the organ's registration at any time during playback, either manually or by using pistons. However, the registration will return to the hymn player default at the beginning of each verse.

B. USB OPERATION

1. USB Memory Port

GeniSys™ consoles are equipped with a USB type memory port. Depending on the model instrument, the USB memory port can be located at various locations on the console. The USB memory port can accept USB flash devices up to 32GB in size.



Important! USB flash devices larger than 32GB will not operate correctly within GeniSys™ model instruments. Data loss may occur if flash devices larger than 32GB are used.



The USB flash device is used for saving or backing up the instrument's capture memories and also for the built-in Sequencer. These functions will not operate unless a USB flash device has been inserted into the USB memory port. However, the USB flash device does not need to be installed for normal playing operation of the instrument.

Insert a USB Flash Device

Locate the USB memory port on the instrument and carefully insert the USB flash device into the port socket. The USB flash device can only be inserted in one orientation, so do not force the USB flash device into the socket if it doesn't fit correctly. Doing so may damage the port socket and the USB flash device. If the USB flash device doesn't fit correctly, re-orient the USB flash device and re-insert it into the port socket. Once the USB flash device is seated correctly into the port socket, the GeniSys™ software will automatically connect to the USB flash device. This will take a few seconds.

Remove a USB Flash Device



Important! Never remove a USB flash device from the USB memory port without first operating the SAFELY REMOVE USB function from within the GeniSys™ Controller. Removing the USB flash device without operating this function may cause data loss to occur on the USB flash device.

To remove a USB flash device, advance to the "SAFELY REMOVE USB" window function (*see Section A-2*).

To remove the USB flash device, press the MEMORY button on the GeniSys™ Controller. The display will return to the Main Window function when it is safe to remove the USB flash device from the USB memory port socket.

Note: If a USB flash device is not connected to the instrument's USB memory port, the SAFELY REMOVE USB function will not appear within the GeniSys™ Controller.

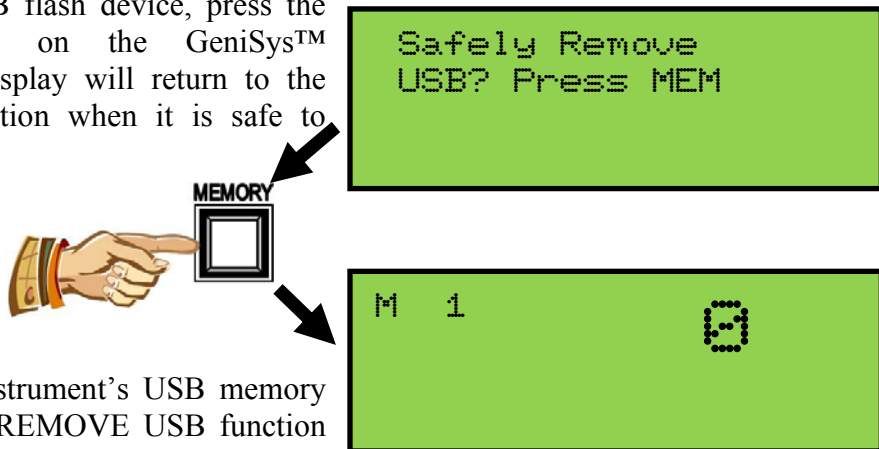

2. GeniSys™ Sequencer

GeniSys™ instruments contain the added versatility of a built-in console sequencer. Similar to the operation of an external MIDI sequencer, the GeniSys™ Sequencer will record and playback an organist's performance in exacting detail. Every key, pedal, piston, stop and expression movement is recorded and played back as it was originally recorded by the organist. Performances can then be saved and loaded for playback at a later time using a USB flash device.



Important! A USB flash device must be connected to the instrument's USB memory port in order to access the Sequencer function within the GeniSys™ Controller. In addition, the Sequencer requires a specific directory structure to operate correctly. The USB flash device included with a GeniSys™ instrument already contains the required directory structure as well as a library of pre-recorded MIDI performances.

The GeniSys™ Sequencer is limited to a single-pass recording. Performance data is saved as a Type 1 MIDI file (multiple MIDI tracks) in standard MIDI file format. The MIDI file may be edited when the USB flash device is inserted into a standard PC computer and more advanced MIDI sequence editing software is used. The GeniSys™ Sequencer will playback both Type 0 and Type 1 MIDI files in standard MIDI file format.

Sequencer "Playlists" may also be created when using an external PC computer and the included librarian software which is located on the USB flash device included with the instrument.

To access the GeniSys™ Sequencer, advance to the Sequencer window function (*see section A2*).

```
SEQNCR PLAY #01  
Work 00000 STOP
```

The GeniSys™ Sequencer contains many display functions. Here is a quick breakdown of those functions and what they do:

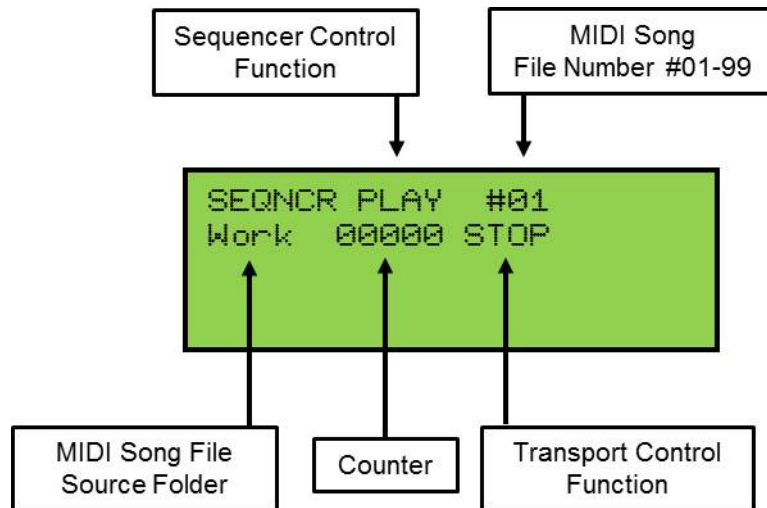

Sequencer Control Function:

- PLAY: Standard Sequencer File Playback; PLAY mode will play the selected MIDI song file number from within the selected MIDI Song File Source Folder.
- PLAY+: “Playlist” Sequencer File Playback; PLAY+ mode will play all MIDI song files from within the selected MIDI Song File Source Folder.
- REC: Record Sequencer File; REC mode will record a performance and save the recorded performance data into the selected MIDI song file number. The MIDI song file location is within the selected MIDI Song File Source Folder.
- DEL: Delete Sequencer File; DEL mode will delete the displayed MIDI song file number from within the selected MIDI Song File Source Folder.

MIDI Song File Number:

MIDI song files use a specific filename format; SONGXX.mid, where “XX” is the file number. Any file number between 01 and 99 may be selected. MIDI song files which do not use the specified filename format will not be recognized by the Sequencer and therefore cannot be loaded for playback.

MIDI Song File Source Folder:

MIDI song files are stored on the USB flash device. The Sequencer uses several pre-defined directories or “source folders” to access MIDI song files. MIDI song files must be located within one of these source folders to be able to be loaded and/or played back.

Counter:

The counter indicates the current position of the Sequencer within a MIDI song file.

Transport Control Function:

- STOP: Stops a MIDI song file from playing.
- FWD: Similar to play, FWD starts the MIDI song file from the current counter position.
- SRCH: Very useful control function that will cause the Sequencer to search from the beginning of the MIDI song file up to the current counter position for any messages pertaining to the organ's stop settings, stop changes, and expression data. This insures the organ is prepared to resume recording/playing the MIDI song file from the current counter position.

a. Select a MIDI Song File Number:

To select a MIDI song file number, press the **CURSOR** button on the GeniSys™ Controller to position the cursor on the MIDI Song File Number. Turn the **ROTARY DIAL** to select a song number. Turning the Rotary Dial clockwise will increase the file number while turning the Rotary Dial counter-clockwise will decrease the file number. Any file number between 01 and 99 may be selected.



b. Select a MIDI Song File Source Folder:

The GeniSys™ Sequencer uses several pre-defined “source folders” or directories in which MIDI song files are stored. Different source folders may be useful for MIDI song file storage and also in case the organist would like to create playlists for sequential playback of MIDI Song Files. The organist may change the MIDI song file source folder at any time.

To change the MIDI Song File Source Folder, press the **CURSOR** button on the GeniSys™ Controller to position the cursor on the MIDI Song File Source Folder.



Turn the **ROTARY DIAL** to change and select a different MIDI Song File Source Folder. The pre-defined source folders available are: Work, List1, List2, List3, List4, List5, List6, List7, List8 and List9.



Important! The Sequencer will not locate or use any other source folders or directories which may exist on the USB flash device other than the listed source folders (above). However, other directories may be utilized for MIDI Song File storage on the USB flash device when using a PC and the included librarian software.

c. Delete a MIDI Song File Number:

To delete a MIDI song file number, press the **CURSOR** button on the GeniSys™ Controller to position the cursor on the Sequencer Control Function.



```
SEQNCR PLAY #01
Work 00000 STOP
```

Turn the **ROTARY DIAL** to select the “DEL” control function. The Transport Control Function will also change to “YES” when “DEL” is selected.



```
SEQNCR DEL #01
Work 00000 YES
```

Select a MIDI Song File Source Folder and MIDI Song File Number (*see sections 2a and 2b above*).

When a MIDI Song File number is selected, press the **CURSOR** button to position the cursor on “YES”.



```
SEQNCR DEL #08
Work 00000 YES
```

Press the **MEMORY** button to delete the selected file number. The display will indicate the MIDI Song File has been deleted.



```
SEQNCR DEL #08
DELETING...
```

```
SEQNCR DEL #08
SUCCESSFUL!
```



Important! If the selected MIDI song file number is not located, the display will indicate “FILE NOT FOUND!”.

```
SEQNCR DEL #08
FILE NOT FOUND!
```

d. Play a MIDI Song File

To load and play a MIDI song file, select a MIDI Song Source Folder and MIDI Song File Number (see sections 2a and 2b above).

Press the **CURSOR** button to position the cursor on the Transport Control Function.



```
SEQNCR PLAY #01
Work 00000 STOP
```

Turn the **ROTARY DIAL** to select the “FWD” control function.



```
SEQNCR PLAY #01
Work 00000 FWD
```

Press the **MEMORY** button to begin playback. The counter will start counting to indicate that playback has started.



```
SEQNCR PLAY #01
Work 00XXX STOP
```



Important! If a selected MIDI Song File is not located when playback is started, the display will indicate “FILE NOT FOUND!” and playback will not begin.

```
SEQNCR PLAY #01
FILE NOT FOUND!
```

When playback begins, notice the Transport Control Function changes to “PAUS” when playback has started. The PAUS function allows the organist to pause or temporarily stop the Sequencer during playback.

```
SEQNCR PLAY #01
Work 00XXX PAUS
```

To “pause” the Sequencer during playback, press the **MEMORY** button. The counter will stop counting and the instrument will stop playing indicating playback has stopped. The Transport Control Function will revert back to “FWD” indicating playback may be resumed at the current counter value.



```
SEQNCR PLAY #01
Work 00XXX FWD
```

Note: The counter value cannot be changed from its current value.

To resume playback, press the **MEMORY** button. The counter will begin counting from the current counter value and the instrument will begin playing indicating playback has resumed. The Transport Control Function will change to “PAUS” in case the organist needs to pause playback again.

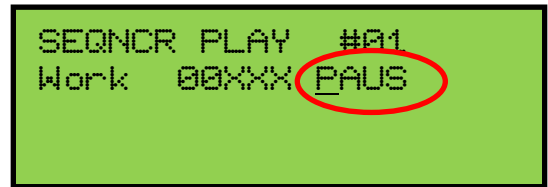

To stop playback, turn the **ROTARY DIAL** to select the “STOP” control function.

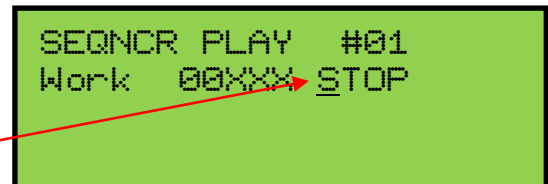

Press the **MEMORY** button to stop playback. The counter will reset to zero (0) and the instrument will stop playing indicating playback has stopped.



e. Play A MIDI Song File From A Different Starting Point (SRCH):

To load and play a MIDI song file from a different starting point, first select a MIDI Song Source Folder and MIDI Song File Number (*see sections 2a and 2b above*).

Press the **CURSOR** button to position the cursor on the counter value.

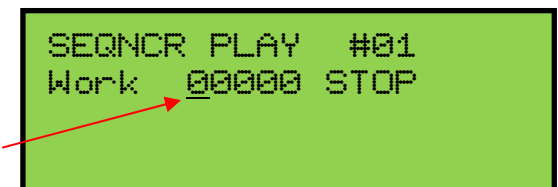

Turn the **ROTARY DIAL** to select a different counter value. Turning the Rotary Dial clockwise will increase the counter number while turning the Rotary Dial counter-clockwise will decrease the counter number.

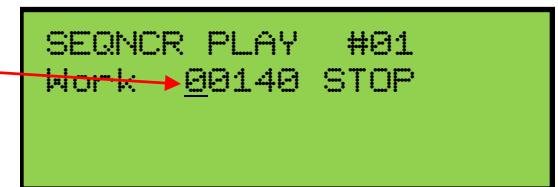

Press the **CURSOR** button to position the cursor on the Transport Control Function.

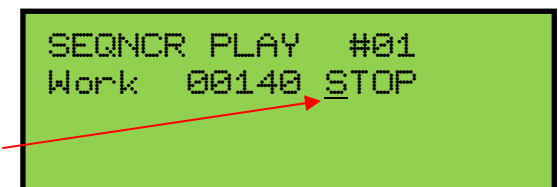

Turn the **ROTARY DIAL** to select the “SRCH” control function.

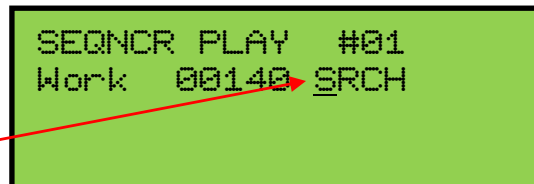

The “SRCH” function scans the MIDI song from the beginning of the MIDI song file up to the current counter position for any messages pertaining to the organ's stop registrations and expression data. The Sequencer will setup the organ with the scanned settings so it is prepared to resume playing the MIDI song file from the current selected counter position. To begin the “SRCH” function, press the **MEMORY** button.

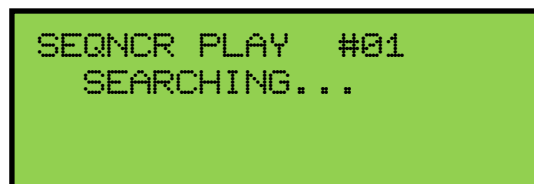

When “SRCH” has completed, the display will indicate the MIDI song file is ready to play by changing the Transport Control Function to “FWD”.

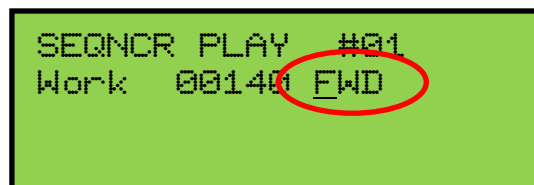

Press the **MEMORY** button to begin playback. The counter will start counting from the current counter value to indicate that playback has resumed.

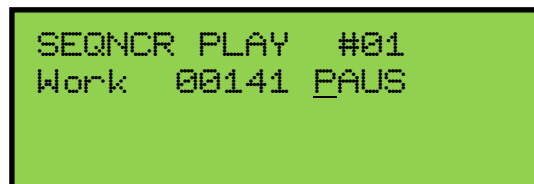

Note: The PAUS and STOP control functions of the Sequencer will operate in the same manner as described in Section 2d.



Important! If the counter value selected is “out of range” and the “SRCH” function is processed, the Sequencer will reset the counter to zero (0) when the MIDI song is played.

f. To Record A MIDI Song:

To record a MIDI song file, select a MIDI Song Source Folder and MIDI Song File Number (see sections 2a and 2b above).

Press the **CURSOR** button on the GeniSys™ Controller until the cursor is positioned on the Sequence Control Function.



Turn the **ROTARY DIAL** to select the REC control function.



Press the **CURSOR** button until the cursor is positioned on the Transport Control Function.

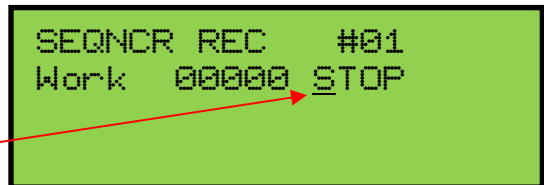

Turn the **ROTARY DIAL** to select the FWD transport control function.

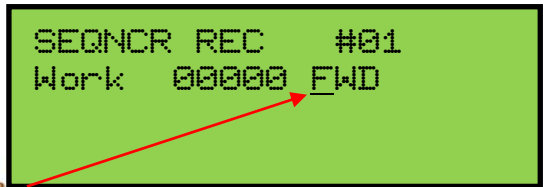

Note: Before starting the actual recording, make sure that all stops are turned off by pressing the CANCEL piston. Then, move the expression shoes to their lowest position.



Hint! To ensure the initial console setup information is recorded within a MIDI song, perform these steps after the recording has started:

1. Press the **CANCEL** piston. This will turn off any stops which are turned on and also record the currently selected capture memory level within the MIDI song. Doing this will set the organ to the correct capture memory level when the MIDI song is played back preventing the potential for incorrect piston registrations to be selected and recorded into the MIDI song.
2. Select a piston registration or manually select stops on the stopboard.
3. Move the expression shoes and set them to a desired position. Doing this will record the organ's volume information within the MIDI song. This way when a MIDI song is played back, the organ's volume will be set to the correct level.

To begin the actual recording, press the **MEMORY** button. The counter will start counting to indicate the Sequencer is now recording. At this point, perform the above instructions (see Hint! above) and begin recording the performance into the Sequencer. All key, pedal, piston, stop or expression movements will be recorded.

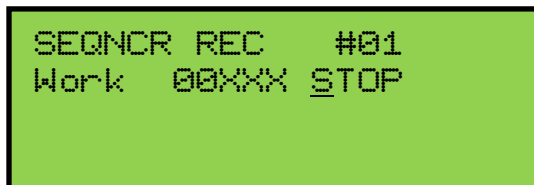

Important! If a selected MIDI Song File already exists when a recording is started, the display will indicate "FILE EXISTS!" and recording will not begin. Delete the current selected MIDI song file number or select a different MIDI song file number to continue.



Notice the Transport Control Function changes to "PAUS" when the recording is started. The PAUS function allows the organist to be able to pause or temporarily stop the Sequencer during a recording.

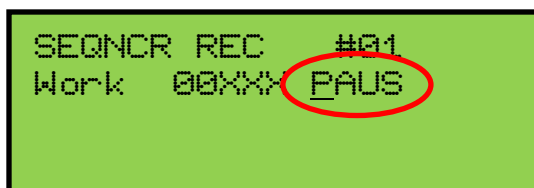

To "pause" the Sequencer during the recording, press the **MEMORY** button. The counter will stop counting indicating the recording has stopped. The Transport Control Function will revert back to "FWD" indicating the recording may be resumed at the current counter value.

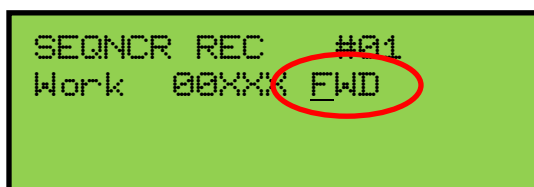

Note: The counter value cannot be changed.



Important! Any registration changes made to the organ while the recording has been paused will not be recorded!

To resume the recording at the current counter value, press the **MEMORY** button. The counter will begin counting from the current counter value indicating the recording has resumed. The Transport Control Function will change to “PAUS” in case the organist needs to pause the recording again.

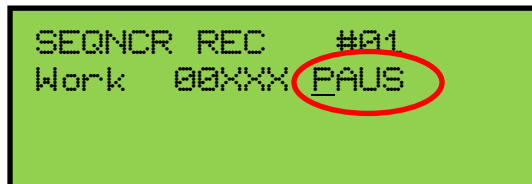

Upon completion of the recording, press the **CANCEL** piston to turn off all of the stops and also move the expression shoes to their lowest position.

Then, turn the **ROTARY DIAL** until the Transport Control Function reads “STOP”.

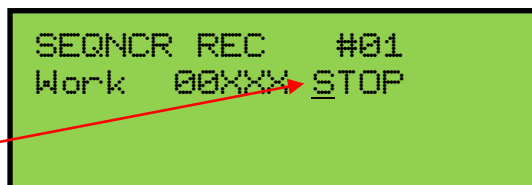

Finally, press the **MEMORY** button. This will stop the recording and automatically set the Sequencer into playback mode.

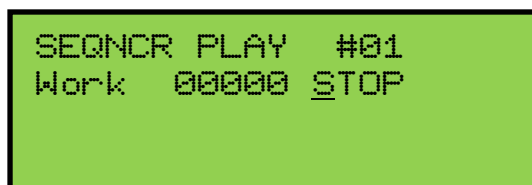

g. Record/Append A MIDI Song File From A Different Starting Point (SRCH):

To append a recording from a different starting point within a MIDI song file, first select a MIDI Song Source Folder and MIDI Song File Number (see sections 2a and 2b above). Place the Sequencer into record mode (see section 2f above).

Press the **CURSOR** button to position the cursor on the counter value.

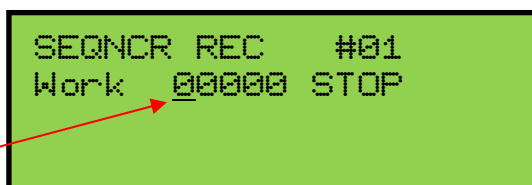

Turn the **ROTARY DIAL** to select a different counter value. Turning the Rotary Dial clockwise will increase the counter number while turning the Rotary Dial counter-clockwise will decrease the counter number.

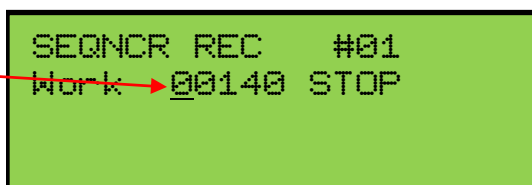

Press the **CURSOR** button to position the cursor on the Transport Control Function.



```
SEQNCR REC #01
Work 00140 STOP
```

Turn the **ROTARY DIAL** to select the "SRCH" control function.



```
SEQNCR REC #01
Work 00140 SRCH
```

The "SRCH" function scans the MIDI song from the beginning of the MIDI song file up to the current counter position for any messages pertaining to the organ's stop registrations and expression data. The Sequencer will setup the organ with the scanned settings so it is prepared to resume recording the MIDI song file from the current selected counter position.

To begin the "SRCH" function, press the **MEMORY** button.



```
SEQNCR REC #01
SEARCHING...
```

When "SRCH" has completed, the display will indicate the MIDI song file is ready to resume recording by changing the Transport Control Function to "FWD".

```
SEQNCR REC #01
Work 00140 FWD
```

Press the **MEMORY** button to resume recording. The counter will start counting from the current counter value to indicate that recording has resumed.



```
SEQNCR REC #01
Work 00141 PAUS
```

Note: The PAUS and STOP control functions of the Sequencer will operate in the same manner as described in Section 2f.



Important! If the counter value selected is "out of range" or past the end of the MIDI song and the "SRCH" function is processed, the Sequencer will resume recording at the selected counter value. If this occurs, there could be a "dead" area within the MIDI song without any data.

h. PLAY+ (Playlist Playback)

The PLAY+ feature will playback a sequential list of MIDI songs within a selected MIDI File Source Folder. The Sequencer will begin playing all MIDI songs, in numerical order, starting with the MIDI file song number shown within the display. For example, if the MIDI file song number is set to “#10” in “List4”, the Sequencer will begin with MIDI file song number #10 and then play all subsequent songs in that playlist/folder. When the Sequencer has reached the last MIDI song within the selected MIDI File Source Folder, playback will automatically stop.

Note: Sequencer “Playlists” may also be created when using an external PC computer and the librarian software on the included USB flash device.

To select the PLAY+ feature, press the **CURSOR** button to position the cursor on the Sequencer Control Function.

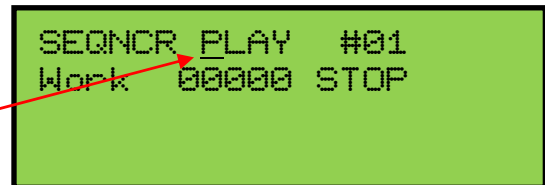

Turn the **ROTARY DIAL** to select the PLAY+ control function.

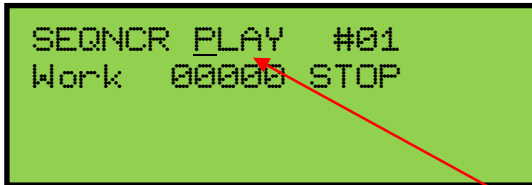

Select a MIDI Song Source Folder and MIDI Song File Number (*see sections 2a and 2b above*).

Press the **CURSOR** button until the cursor is positioned on the Transport Control Function.

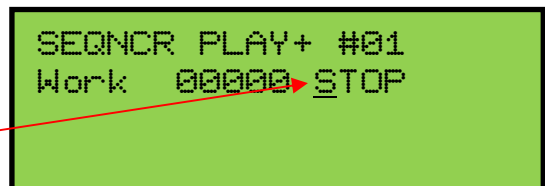

Turn the **ROTARY DIAL** to select the FWD transport control function.

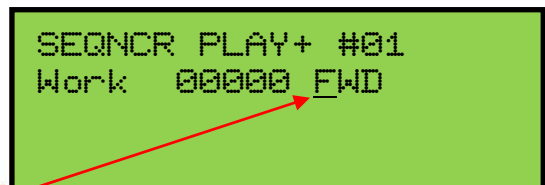

Press the **MEMORY** button to begin playback. The counter will start counting to indicate that playback has started.

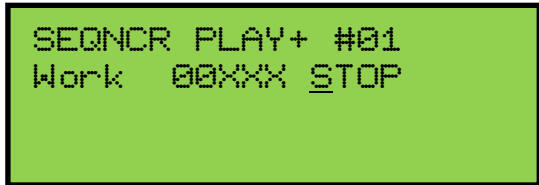

Important! If the selected MIDI song file number is not located when playback is started, the display will indicate “FILE NOT FOUND!” and playback will not begin. Select a different MIDI song file number to continue.

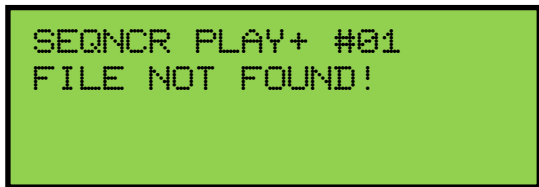

Note: The PAUS and STOP control functions of the Sequencer will operate in the same manner as described in Section 2d.

3. Capture Memory Registration Save/Load

All GeniSys™ instruments can both save and load capture registration data to the USB flash device. Capture registrations, piston configuration, MIDI settings, Crescendo/Tutti B settings and Piston Sequencer data (when applicable) can be saved and loaded using the GeniSys™ Controller when a USB flash device is inserted into the USB memory port.

To access the Capture Save feature, advance to the CAPTURE MEMORY window function (see section A-2).



Important! A USB flash device must be inserted into the USB memory port in order for the capture save/load feature to be available. Registration files are stored within the “root” directory of the USB flash device and use the standard MIDI System Exclusive or MIDI Sysex data file format with the (.syx) extension.

The Capture Memory feature contains several display functions. Here is a quick breakdown of those functions and what they do:

Mode Select: LOAD, SAVE or DEL.

LOAD: Loads a selected capture file number.

SAVE: (3) options (**Type Select**):

“ALL” Saves all capture registrations, piston configuration, MIDI settings, Crescendo/Tutti B settings and Piston Sequencer data (when applicable).

“PCF” Saves only the piston configuration data.

“CRB” Saves only the Crescendo/Tutti B data.

DEL: Deletes the selected capture file number.

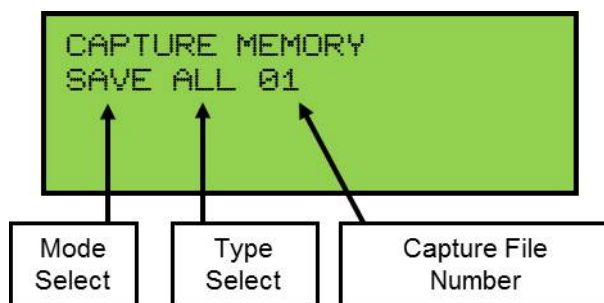

a. Delete a Capture File

To delete an existing capture file number, press the **CURSOR** button and position the cursor on the Mode Select value.



```
CAPTURE MEMORY
SAVE ALL 01
```

Turn the **ROTARY DIAL** to select "DEL" mode.



```
CAPTURE MEMORY
DEL 01
```

Select a Capture File Number. Press the **CURSOR** button to position the cursor on the Capture File Number value.



```
CAPTURE MEMORY
DEL 01
```

Turn the **ROTARY DIAL** to select a capture file number. Turning the Rotary Dial clockwise will increase the file number while turning the Rotary Dial counter-clockwise will decrease the file number. Any file number between 01 and 99 may be selected.



```
CAPTURE MEMORY
DEL 10
```

To delete the selected capture file number, press the **CURSOR** button to position the cursor on the Mode value, DEL.



```
CAPTURE MEMORY
DEL 10
```

Press the **MEMORY** button. The display will briefly indicate when the file has been deleted.



```
CAPTURE MEMORY
DEL 10
```



```
CAPTURE MEMORY
SUCCESS!
```



Important! If the selected capture file number does not exist, the display will indicate “ERR NO SUCH FILE!” To continue, select a different capture file number.



b. Load a Capture File

To load an existing capture file number, press the **CURSOR** button and position the cursor on the Mode Select value.



Turn the **ROTARY DIAL** to select “LOAD” mode.



Select a Capture File Number. Press the **CURSOR** button to position the cursor on the Capture File Number value.



Turn the **ROTARY DIAL** to select a capture file number. Turning the Rotary Dial clockwise will increase the file number while turning the Rotary Dial counter-clockwise will decrease the file number. Any file number between 01 and 99 may be selected.

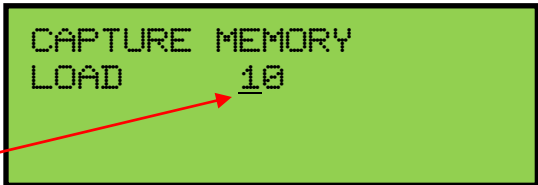

To load the selected capture file number, press the **CURSOR** button to position the cursor on the Mode value, LOAD.



Press the **MEMORY** button. The display will indicate when the file has been loaded.



```
CAPTURE MEMORY
LOAD      10
```



```
CAPTURE MEMORY
LOADING...
```



```
CAPTURE MEMORY
SUCCESS!
```

The capture system will also turn off or cancel all stops when loading is complete.



Important! If the selected capture file number does not exist, the display will indicate “ERR NO SUCH FILE!” To continue, select a different capture file number.

```
CAPTURE MEMORY
ERR NO SUCH FILE!
```

c. Save a Capture File

To perform a capture save, make sure the Mode Select value is set to SAVE. If not, press the **CURSOR** button to position the cursor on the Mode Select value.



```
CAPTURE MEMORY
LOAD      01
```

Turn the **ROTARY DIAL** to select “SAVE” mode.



```
CAPTURE MEMORY
SAVE ALL 01
```

Select the Capture Save type. Press the **CURSOR** button to position the cursor on the Type Select value.



```
CAPTURE MEMORY
SAVE ALL 01
```

Turn the **ROTARY DIAL** to select one of the (3) available Capture Save types: ALL, PCF or CRB (*see section 2 above for a description of the different Capture Save types*).



```
CAPTURE MEMORY
SAVE ALL 01
```

Select a Capture File Number. Press the **CURSOR** button to position the cursor on the Capture File Number value.



```
CAPTURE MEMORY
SAVE ALL 01
```

Turn the **ROTARY DIAL** to select a file number. Turning the Rotary Dial clockwise will increase the file number while turning the Rotary Dial counter-clockwise will decrease the file number. Any file number between 01 and 99 may be selected.



```
CAPTURE MEMORY
SAVE ALL 10
```

To **SAVE** the selected capture data type, press the **CURSOR** button to position the cursor on the Mode value.



```
CAPTURE MEMORY
SAVE ALL 10
```

Press the **MEMORY** button. The display will indicate the status of the capture save and when it has completed.



```
CAPTURE MEMORY
SAVE ALL 10
```



```
CAPTURE MEMORY
SUCCESS!
```



Important! If a selected capture file number already exists when starting the save process, the display will indicate “ERR FILE EXISTS!” and the capture data save will not be saved. To continue, delete the current selected capture file number or select a different capture file number.



C. ADVANCED OPERATION

1. Selecting an Alternate Tuning

Advance to the ‘ALTERNATE TUNING’ window function (*see section A-2*).

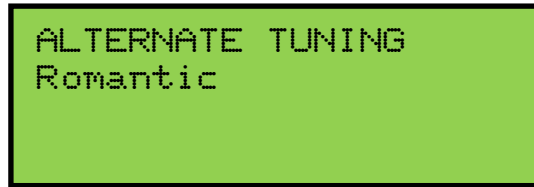

(The current Alternate Tuning will appear on line 2 of the display)



Allen Organs offer eight *Alternate Tunings*, plus one standard tuning. These tunings are accessible from the GeniSys™ Controller. To select an *Alternate Tuning*, press the **CURSOR** button on the GeniSys™ Controller until the cursor is positioned on the Alternate Tuning name (*line 2*). Turn the **ROTARY DIAL** to select one of the eight available tunings. The organ’s overall tuning will be changed to the selected *Alternate Tuning*, by actuating the stop control engraved “ALTERNATE TUNING”.



The selected tuning will remain the *Alternate Tuning* until:

- ❑ Another *Alternate Tuning* is selected in the GeniSys™ Controller,
- ❑ Or, the stop control is turned off.

Any time the ALTERNATE TUNING stop is off, the organ reverts to a standard general purpose tuning. **Note:** *The remaining tunings are of historical interest, but are limited in application to modern music. When selected, it is normal for some intervals to sound out of tune.*

Alternate Tunings:

1. Romantic
2. Classic
3. Baroque
4. Kirnberger 3
5. Werckmeister 3
6. Just Intonation
7. Young 2
8. Pythagorean

2. Configuring General Pistons

This procedure enables pistons to control stops that are normally not controlled by those pistons.

Important! The Piston Configuration is common to all capture memories.

For example:

- (1) Pistons can be configured to control only certain specific stops.
- (2) A piston can be configured so that it will only affect the Tremulant stops.
- (3) A General piston can be configured to respond like a Divisional Piston.

Note 1: Changing the configuration of a piston *will not affect the registrations* previously remembered by that piston prior to its reconfiguration.

Note 2: Reconfiguring a piston does not change its MIDI channel assignment.

Configuring General Pistons to only affect MIDI stops:

Advance to the 'CONFIGURE PISTONS' window function (*see section A-2*).

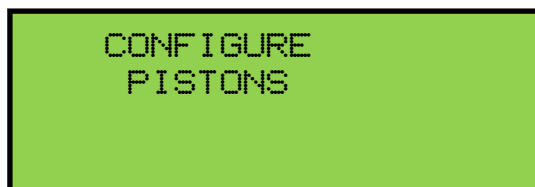

At this point, pressing any piston will actuate stops controlled by that particular piston.

EXAMPLE CONFIGURATIONS

To reconfigure a piston to control only the MIDI stops:

Select just the MIDI stop controls. Press and hold the **SET** piston. Then, while holding **SET**, press a General piston that you want only the MIDI stops to respond on. Release both. The General piston just pressed will now only be able to program the MIDI stop controls and will no longer affect other stops.

To reconfigure a General Piston so it controls only the Swell Division stops:

Select *all* of the Swell division stops. Press and hold the **SET** piston. Then, while holding **SET**, press a General piston that you want only the Swell division stops to respond on. Release both. The General piston just pressed will now only be able to program the Swell division stops and will no longer affect other stops.

To add the “Swell To Great” Intermanual Coupler to the Great Divisional Pistons:

Select *all* of the Great Division stops controls and also the “Swell To Great” intermanual coupler. Press and hold the **SET** piston. Then, while holding **SET**, press each Great Divisional Piston, in sequence while holding **SET**. Release **SET** when completed. The “Swell To Great” coupler can now be registered to the Great Divisional pistons.

To reconfigure a General/Divisional Piston so it controls only the Tremulant stops:

Select *all* of the organ’s Tremulant sop controls. Press and hold the **SET** piston. Then, while holding **SET**, press a General/Divisional piston. The General/Divisional piston just pressed will now only be able to program the Tremulant stops and will no longer affect other stops.

To return to the *Main Window* to store registrations to the pistons you just configured, press and hold the **SET** piston. Then, while holding **SET**, press **CANCEL**. Release both. (See Section A-4).

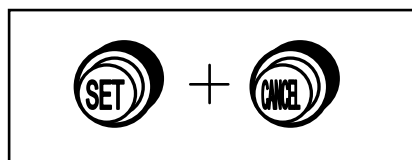

The use of the CONFIGURE PISTONS function is only limited by one's creative imagination.

Remember: The above examples only determine which stops will become accessible by the reconfigured pistons; *they will not change any previously saved registrations.*

3. Restoring Original Factory Settings

Advance to the 'RE-INITIALIZE' window function (see Section A-2). The window will display...

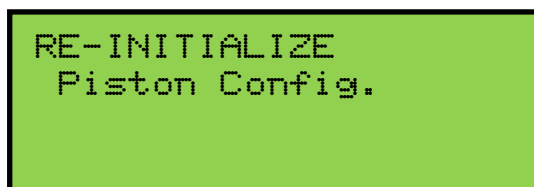

Certain functions can be restored to the original factory settings. They are:

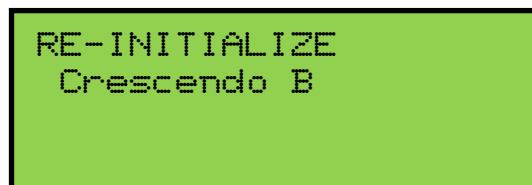
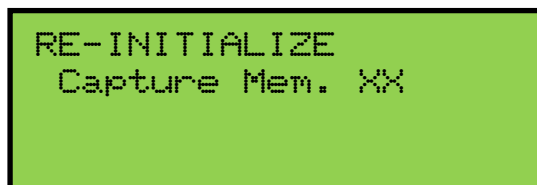
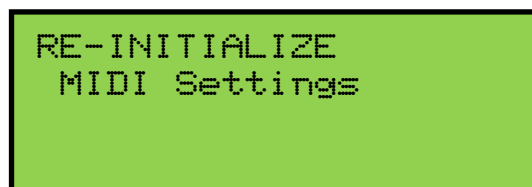
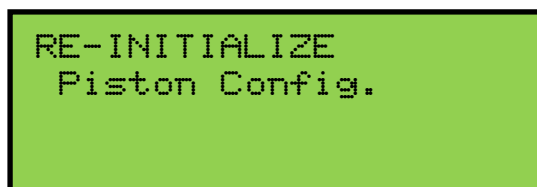

The Piston Configuration re-initialization includes all the Configure Piston settings. The MIDI Settings re-initialization includes all MIDI program change mapping. The Capture Memory re-initialization will reset the last available capture memory to factory default registrations (*if applicable*).



Each of these functions can be restored individually. To select the factory settings you wish to restore press the **CURSOR** button until the cursor is positioned on the parameter value located on the 2nd line of the display. Then, turn the **ROTARY DIAL** to select the desired setting to re-initialize.



Press and hold the **MEMORY** button. Then, while holding **MEMORY**, press General Pistons 2-5-5 in sequence.

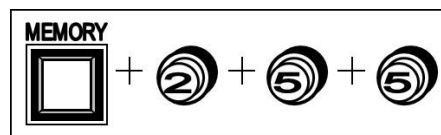

The display will briefly flash the word "WORKING" on the first line of the display to indicate that the current command function is being re-initialized.

4. Global Tuning

Global Tuning allows the organist to adjust the pitch of the entire organ. This tuning adjustment allows the organ to be tuned to another instrument more easily. Tuning can be adjusted either ± 100 cents from A-440 pitch. To adjust Global Tuning, advance to the 'GLOBAL TUNING' window function (*see Section A-2*).



Press the **CURSOR** button until the cursor is positioned on the tuning value. Turn the **ROTARY DIAL** in either direction to raise or lower the pitch of the organ. Turning the ROTARY DIAL clockwise will raise the pitch while turning the ROTARY DIAL counter-clockwise will lower the pitch.

Note: The Global Tuning adjustment will be retained in memory when the organ is powered off.

5. Headphone Volume (*optional*)

The master headphone volume control is integrated into the GeniSys™ Controller. Adjusting this setting will change the overall output volume level of the headphone in relation to the organ's expression pedal. To adjust the headphone volume, advance to the "HEADPHONE MASTER" window function (*see Section A-2*).

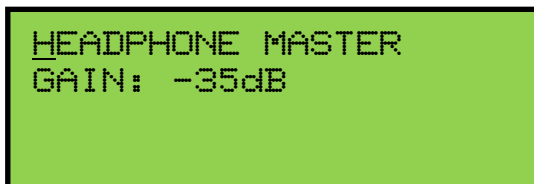

To change the Headphone Master Gain setting, press the **CURSOR** button until the cursor is positioned on the Gain setting value. Turn the **ROTARY DIAL** to change the gain setting. Gain adjustment range is from (off) or minus 35dB to +6db. Minus 35db is the least amount of gain while +6dB is the most or maximum amount of gain.

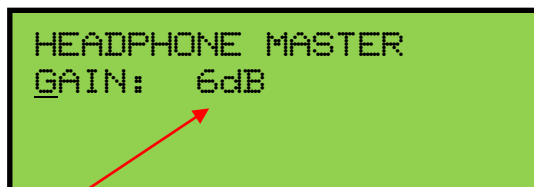
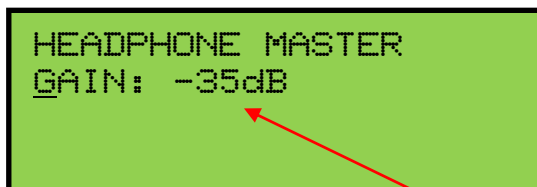

6. Modifying the Crescendo and Tuttis

The original factory settings include a second set of Tuttis and a second set of Crescendo settings that can be altered to suit an organist's needs.

Advance to the 'CRESC/TUTTI B' window function (*see section A-2*). There are two modes available in this window function, "SET" and "SHOW".

SET Mode: Set mode allows the organist to create or edit a Crescendo B sequence.

SHOW Mode: Show mode allows the organist to view the Crescendo B sequence using the **ROTARY DIAL** on the GeniSys™ Controller or by using the Crescendo Shoe.



To toggle between modes press the **CURSOR** button on the GeniSys™ Controller until the cursor is positioned on the mode name (*Set or Show*). Turn the **ROTARY DIAL** to change modes. The display will indicate which mode is activated.

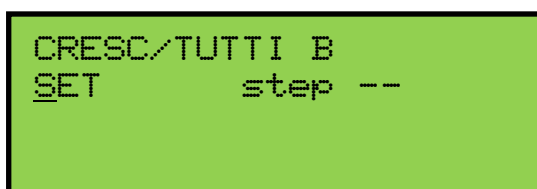

To view the stops/drawknobs registered on the second (B) TUTTI I or TUTTI II, press either TUTTI. This will cause all associated stops/drawknobs programmed on the selected TUTTI to turn on.

Setting a Crescendo B Sequence:

The Crescendo includes 22 positions evenly dispersed along the Crescendo shoe's range of travel. To set a Crescendo B sequence, advance to the 'CRESC/TUTTI B' window function (*see Section A-2*). Press the **CURSOR** button until the cursor is positioned on the word "step" on line two. Turn the **ROTARY DIAL** to change the step positions.



The word "step xx" indicates that you are now editing or viewing (*dependent if SET or SHOW mode is active*) the Crescendo B sequence. The "step xx" indicator will display either "step --" to indicate position 0 (*Crescendo shoe off*) or any step between 1 and 22. Any stops/controls associated with a particular Crescendo step will indicate their status **when using the Crescendo Shoe only**. While in 'SET' mode, turning the **ROTARY DIAL** will not cause the stops/controls to indicate their status.



To 'SET' a Crescendo B sequence, first make sure that **SET** mode is selected. Then, press the **CURSOR** button to re-position the cursor and turn the **ROTARY DIAL** to select step 1. Adjust the stops to a suitable registration for step 1. (*Note: You can play the organ at any time to hear the selected registration*) Press and hold the **SET** piston, then while holding **SET** press the **MEMORY** button in the GeniSys™ Controller. "DONE!!" will briefly flash on the first line of the display to indicate the step has been programmed.



Release both the **SET** piston and **MEMORY** button. Step 1 is now programmed. Repeat the above procedure to set all available crescendo step positions.



Important! DO NOT USE THE CRESCENDO SHOE TO MOVE BETWEEN STEPS WHILE PROGRAMMING CRESCENDO B STEP POSITIONS. Crescendo B data in other step positions will cause the current stop registration displayed to change, i.e. a blank step position would turn all stops off or another subsequent step position with data (*not yet re-programmed*) will change the current stop registration. When programming the Crescendo, always use the **ROTARY DIAL** to move between steps.

To copy the current Crescendo step's stop registration to another step, use the **ROTARY DIAL** to select a different step. Press and hold the **SET** piston, then while holding **SET** press the **MEMORY** button on the GeniSys™ Controller. The display will briefly flash the word "DONE!!" on the first line. Release both the **SET** piston and **MEMORY** button. The previous step has now been copied to the step position indicated in the display.

Editing A Crescendo B Sequence

Advance to the 'CRESC/TUTTI B' window function (*see section A-2*). To enter the "SHOW" mode, press the **CURSOR** button until the cursor is positioned on the mode name within the GeniSys™ Controller. Turn the **ROTARY DIAL** until the word "SHOW" appears in the display. Press the **CURSOR** button until the cursor is positioned on the word "step" in the display. As before, the display will indicate which step is currently activated. Use the **ROTARY DIAL** to move through the step positions one by one while observing the stops/controls. The stops/controls will change accordingly as to which step position is currently active.



```
CRESC/TUTTI B
SHOW      step --
```

To edit a step position you must re-enter the "SET" mode by pressing the **CURSOR** button until the cursor is positioned on the mode name "SHOW". Turn the **ROTARY DIAL** until the word "SET" appears in the display.

Note: The step position indicator will remain at the current step position that was selected in "SHOW" mode.



Important: DO NOT MOVE THE CRESCENDO SHOE AT THIS TIME.

Adjust the stop registration for that step. Once changes to the registration are complete, save the step by pressing and holding the **SET** piston. Then, while holding **SET** press the **MEMORY** button. The display will briefly flash the word "DONE!!" on the first line. Release both the **SET** piston and **MEMORY** button. The step is now saved to the step position indicated in the display. To continue viewing steps you must return to "SHOW" mode by pressing the **CURSOR** button until the cursor is re-positioned on the word "step" within the display. Turn the **ROTARY DIAL** to view additional Crescendo steps.



Hint: While in "SET" mode you can view the Crescendo B sequence without having to enter the "SHOW" mode by using the Crescendo shoe. However, it is important that all Crescendo step positions be programmed before doing this. By depressing the Crescendo shoe, the stops/controls will move accordingly as to the step displayed. You may play the organ while moving the crescendo shoe to hear the Crescendo sequence.

Manually disabling Celestes and Tremulants:

To manually disable the celestes and/or tremulants at any of the available Crescendo B steps positions, advance to the 'CRESC B CUTOUT' window function (*see section A-2*).



```
CRESC B CUTOUT
LEVEL: DISABLED
```



Press the **CURSOR** button until the cursor is positioned on the 'LEVEL' setting located on line two of the display. If the LEVEL setting is set to DISABLED, turn the **ROTARY DIAL** counter-clockwise to select a specific step position on which the cutout is to occur. Otherwise, turning the **ROTARY DIAL** either direction will raise or lower the step position number. To disable the Crescendo B cutout, turn the **ROTARY DIAL** clockwise until the word "DISABLED" appears.



Note: Registrations and/or the memory settings for the PISTONS are not affected by resetting the Crescendo B.



Play Organ Using Secondary Crescendo B

The *Main Window* function must be displayed (*see Section A-2*). Press the **CRES. B** piston. On the bar-graph display, the green CRESC-B indicator will illuminate. Depress the Crescendo shoe and play the organ.



Editing Tutti B Registrations

Advance to the 'CRESC/TUTTI B' window function (*see Section A-2*). The display will automatically revert to "SET" mode when pressing either Tutti piston if in the "SHOW" mode.



```
CRESC/TUTTI B
SET      step --
```

To view a Tutti registration, press either Tutti piston. The display will indicate which Tutti was selected.

You may now view/edit the Tutti registration. To save any changes press and hold the **SET** piston. Then, while holding **SET**, press the **MEMORY** button. The display will briefly flash the word "DONE!!" on the first line. Release both the **SET** piston and **MEMORY** button. The new Tutti registration is now stored as the Tutti number indicated in the display.

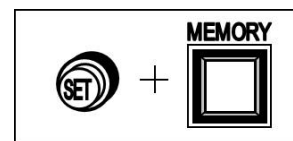

Playing the organ Using Secondary Tuttis

The *Main Window* function must be displayed (*see Section A-2*). Press the **CRES. B** piston. On the bar-graph display, the green CRESC-B indicator will illuminate. Press the **Tutti** piston of your choice. The bar-graph's red Tutti indicators will light to indicate which Tutti is active.

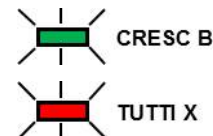

7. Sostenuto (optional)

Sostenuto is an Italian word meaning “sustained.” Unlike the sustain switch, which sustains any notes played as long as the sustain switch is held on, the *Sostenuto* switch sustains only the notes being held at the very moment it is pressed. *Sostenuto* is actuated by the organ’s MIDI Sustain switch (which is optional on some organs) located to the left of the Great/Pedal expression shoe. The *Sostenuto* function must first be enabled before using it.

Advance to the ‘SOSTENUTO’ window function (*see Section A-2*).

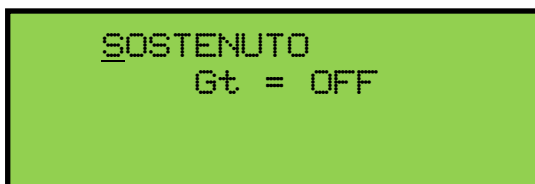

The display will indicate which manual *Sostenuto* is assigned to and indicate the current on/off status.

Note: The manual which *Sostenuto* is assigned to cannot be changed, but the on/off status can.

To change the status of the *Sostenuto* function, press the **CURSOR** button to position the cursor on the status value.

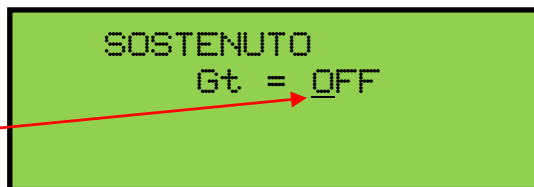

Then, turn the **ROTARY DIAL** to change the on/off status.



Important! *Sostenuto* will affect the internal voices of the organ as well as a MIDI instrument connected to the MIDI output. Keep in mind that the Sustain function will operate in tandem with the *Sostenuto* function.

Note: Check your specific MIDI instrument’s owner’s manual to verify that it will receive and/or respond to MIDI *Sostenuto* messages.

8. Piston Sequencer

The Piston Sequencer allows the organist to step through a sequence of registrations using piston/toe studs labeled "+" and "-". Four modes of operation are available.

OFF: The Piston Sequencer is disabled. The "+" and "-" pistons/toe studs will not function.

SIMPLE STEPPER: This mode allows the organist to step sequentially through the available General pistons of a single capture memory level.

ADVANCED STEPPER: This mode allows the organist to step sequentially through the available General pistons of all capture memory levels.

CUSTOM SEQS: This mode allows the organist to step sequentially through a user programmed piston sequence of any available piston and capture memory level. Piston Sequence memory allows 512 steps allocated to a maximum of 99 sequences.

Note: Custom piston sequence data will be saved to the USB flash device when selecting the ALL capture data type option when saving capture memory registration data (*see section B-3 in this manual for more information*).

OFF MODE

To select the OFF mode, advance to the 'PISTON SEQUENCER' window function (*see Section A-2*).

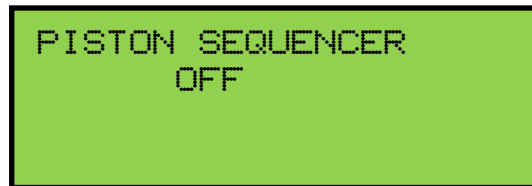

Note: The organ will remember the Piston Sequencer mode setting when power is turned off. If Piston Sequencer was previously enabled previously, the OFF mode may be selected to disable the Piston Sequencer.

Press the **CURSOR** button to position the cursor on the mode value line.

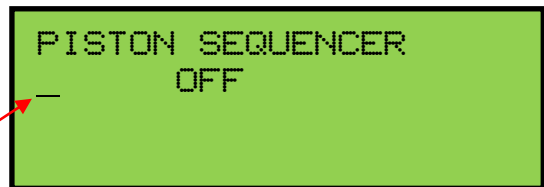

Turn the **ROTARY DIAL** to select OFF mode.



SIMPLE STEPPER MODE

To select the SIMPLE STEPPER mode, advance to the 'PISTON SEQUENCER' window function (*see Section A-2*).

Press the **CURSOR** button to position the cursor on the mode value line.

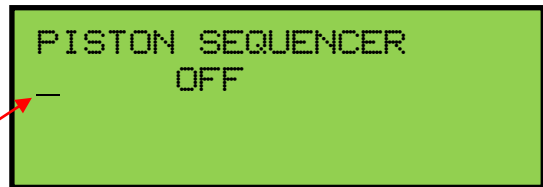

Turn the **ROTARY DIAL** to select SIMPLE STEPPER mode.

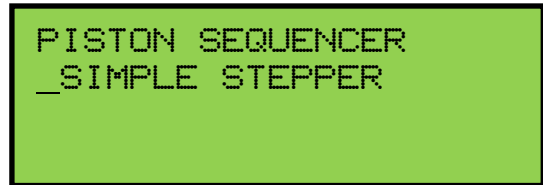

To use the SIMPLE STEPPER, return to the *Main Window* function. Press and hold the **SET** piston. Then, while holding **SET**, press the **CANCEL**.

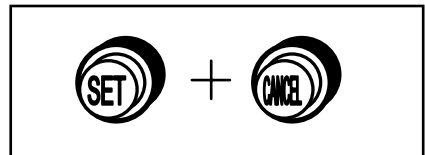

USING THE SIMPLE STEPPER

If the SIMPLE STEPPER mode is activated, the abbreviation “SS” will appear on the second line of the display. Using the pistons/toe studs labeled “+” or “-“, the SIMPLE STEPPER will step up or down sequentially through all General Piston positions within the selected capture memory level, stopping when either extreme is reached.

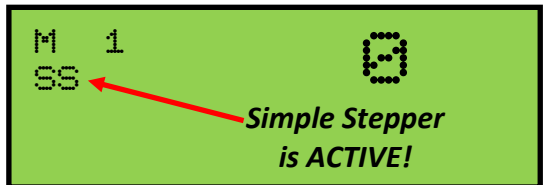

To start SIMPLE STEPPER, select a capture memory level (*see Section A-3*) and then press General piston #1. The registration associated with the selected capture memory level and General piston #1 will register on the stops and the display will indicate that General #1 has been pressed. This will also set the SIMPLE STEPPER’s starting step position.

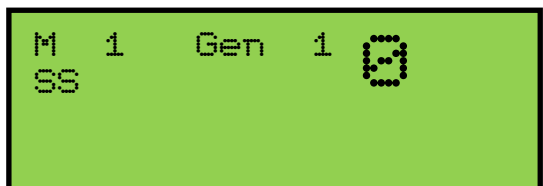

Note: Pressing the “+” or “-“ piston will also select General #1 and also set the SIMPLE STEPPERS starting step position.

Pressing the “+” piston/toe stud will select the next General piston number, in this case General Piston #2.

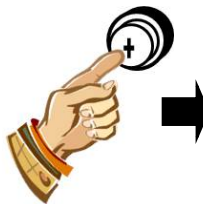

Remember! If General #1 is displayed, the “-“ piston will do nothing since General #1 is the lowest possible General piston number available.

The SIMPLE STEPPER's step position may be changed at any time, on-the-fly, by pressing a different General piston than the one displayed. SIMPLE STEPPER will then step up or down from the newly selected General piston number when either the "+" or "-" piston/toe stud are pressed.

For example; if the SIMPLE STEPPER's current step position is General #4, pressing General #7 will not only change the registration, but will also set the SIMPLE STEPPER's step position to General #7. At this point, pressing either the "+" or "-" piston/toe stud will step up or down from General #7.

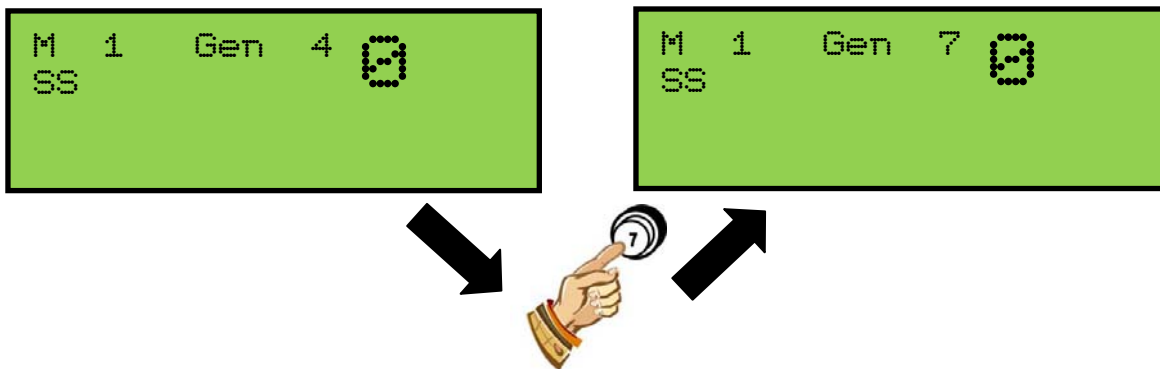

The capture memory level may also be changed at any time while within the SIMPLE STEPPER mode. To change the capture memory level, press the **CURSOR** button to position the cursor on capture memory level value. Then, turn the **ROTARY DIAL** to select a different capture memory level (*see Section A-3*).



Important! Changing the capture memory level will reset the SIMPLE STEPPER's step position value back to General #1. The organist will need to set a new starting step position by selecting and pressing a General piston or the organist can automatically start at General #1 by pressing the "+" or "-" piston/toe stud.

The SIMPLE STEPPER will remember the last General piston pressed and will resume stepping from that step position based on whether the "+" or "-" piston/toe stud is pressed. Even if the **CANCEL** piston is pressed and the piston display cleared and/or a Divisional piston is pressed, the SIMPLE STEPPER will remember the last General piston pressed and will resume stepping from that step position.

Example #1: General #5 is the current selected General piston. The organist presses **CANCEL**. The organist then presses the "+" piston. The piston display now indicates General #6 and sets the registration accordingly.

Scenario: General #6 was selected because General #5 was the last active General piston before **CANCEL** was pressed and even though the piston display was blank.

ADVANCED STEPPER MODE

To select the ADVANCED STEPPER mode, advance to the 'PISTON SEQUENCER' window function (*see Section A-2*).

Press the **CURSOR** button to position the cursor on the mode value line.

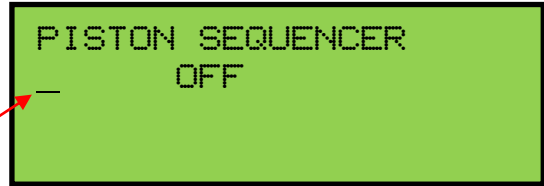

Turn the **ROTARY DIAL** to select ADVANCED STEPPER mode.

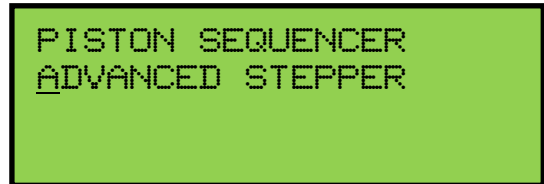

To use the ADVANCED STEPPER, return to the *Main Window* function. Press and hold the **SET** piston. Then, while holding **SET**, press the **CANCEL**.

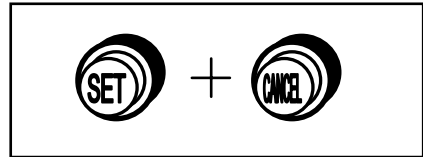

USING THE ADVANCED STEPPER

If the ADVANCED STEPPER mode is active, the abbreviation “AS” will appear on the second line of the display. Using the pistons/toe studs labeled “+” or “-”, the ADVANCED STEPPER will step up or down sequentially through all General Piston positions and through all capture memory levels, stopping when either extreme is reached.

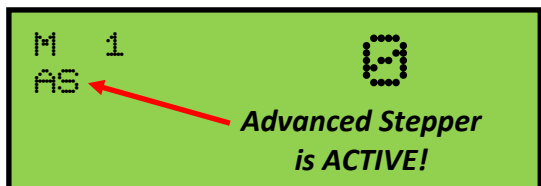

To start ADVANCED STEPPER, select a capture memory level (*see Section A-3*) and then press General piston #1. The registration associated with the selected capture memory level and General piston #1 will register on the stops and the display will indicate that General #1 has been pressed. This will also set the SIMPLE STEPPER’s starting step position.

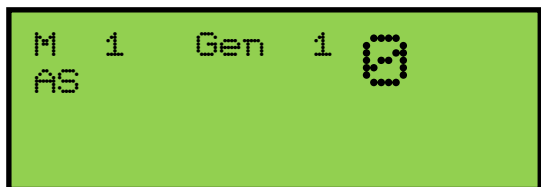

Note: Pressing the “+” or “-” piston will also select General #1 and also set the ADVANCED STEPPERS starting step position.

Pressing the “+” piston/toe stud will select the next General piston number, in this case General Piston #2.



Remember! If capture memory level #1 is selected and General #1 is displayed, the “—” piston will do nothing since General #1 is the lowest possible General piston number available.

Pressing the “+” piston/toe stud will begin stepping through each General piston number from the starting step position within the selected capture memory level. When General #10 is reached and the “+” piston is pressed, the capture memory level value will increment by one (1) and General #1 will be selected within the next highest capture memory level. The same is true in reverse when the “—” piston is pressed. However, when General #1 is reached and the “—” piston is pressed, the capture memory level will decrement by one (1) and General #10 will be selected within the next lowest capture memory level.

As with the SIMPLE STEPPER, the ADVANCED STEPPER’s step position may be changed at any time, on-the-fly, by selecting a different capture memory level and/or also by pressing a different General piston other than the one displayed within the selected capture memory level. The ADVANCED STEPPER will then step up or down from the newly selected capture memory level and/or General piston number when either the “+” or “—” piston/toe stud are pressed.

To change the capture memory level, press the **CURSOR** button to position the cursor on capture memory level value. Then, turn the **ROTARY DIAL** to select a different capture memory level (*see Section A-3*).



Important! Changing the capture memory level will reset the ADVANCED STEPPER’s step position back to General #1 within the newly selected capture memory level. The organist will need to set a new starting step position by selecting and pressing a General piston or the organist can automatically start at General #1 by pressing the “+” or “—” piston/toe stud.

To select a different General piston as a starting step position within the current capture memory level, simply press another General piston number.

The ADVANCED STEPPER will also remember the last General piston pressed and will resume stepping from that step position based on whether the “+” or “—” piston/toe stud is pressed. Even if the **CANCEL** piston is pressed and the piston display cleared and/or a Divisional piston is pressed, the ADVANCED STEPPER will remember the last General piston pressed and will resume stepping from that step position.

Example #2: General #9 is the current selected General piston. The organist presses Swell Divisional piston #4 to change only the Swell registration briefly (Sw 4 is shown within the piston display) and then presses the “+” piston to continue. The piston display indicates General #10 and sets the registration accordingly.

Scenario: General #10 was selected because General #9 was the last active General piston before Swell Divisional #4 was pressed. Divisional pistons are not recognized as valid step positions when using either the SIMPLE or ADVANCED STEPPER modes.

CUSTOM SEQUENCE MODE

To select the CUSTOM SEQUENCE mode, advance to the 'PISTON SEQUENCER' window function (*see Section A-2*).

Press the **CURSOR** button to position the cursor on the mode value line.

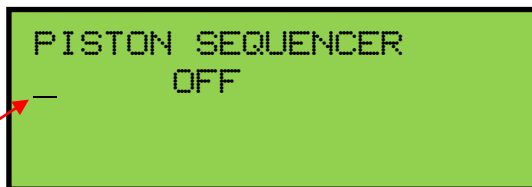

Turn the **ROTARY DIAL** to select the CUSTOM SEQUENCES mode. The display will also indicate the number of custom piston sequences saved within memory. Up to 99 custom piston sequences are available.

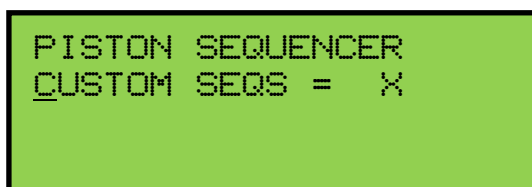

To use the CUSTOM SEQUENCER mode, return to the *Main Window* function. Press and hold the **SET** piston. Then, while holding **SET**, press the **CANCEL**.

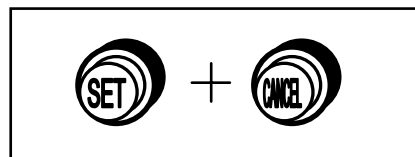

A custom piston sequence is completely programmable by the organist. Each step position is assigned a capture memory level, General or Divisional manual piston assignment and a piston number. This gives the organist the flexibility to be able to switch capture memory levels and piston assignments between each step position. The custom piston sequence can then be maneuvered sequentially through each programmed step by using the "+" or "—" piston buttons, stopping when either extreme is reached.

CUSTOM PISTON SEQUENCE EDITING FUNCTIONS

Custom Piston Sequences are created and modified within the editing window functions following the 'PISTON SEQUENCER' mode selection window and is only available if the Custom Sequence mode is enabled. There are four different editing functions available:

INSERT: Insert allows the organist to enter a new sequence or a new step within an existing piston sequence.

EDIT: Edit allows the organist to make changes to existing programmed steps. Capture memory level, piston division, and piston number may be edited within any step position.

SHOW: Show allows the organist to step through a piston sequence viewing the capture memory level, piston, and stop registration of each step.

DELETE: Delete allows the user to remove an existing sequence or step within a piston sequence.

INSERT--CREATING A NEW CUSTOM SEQUENCE OR STEP

Advance to the 'PISTON SEQUENCER' window function (*see Section A-2*). Make sure CUSTOM SEQUENCE mode is selected and the cursor is positioned on the "Menu Function" and then advance to the next window function (*see Section A-2*) to access the piston sequencer editing functions.

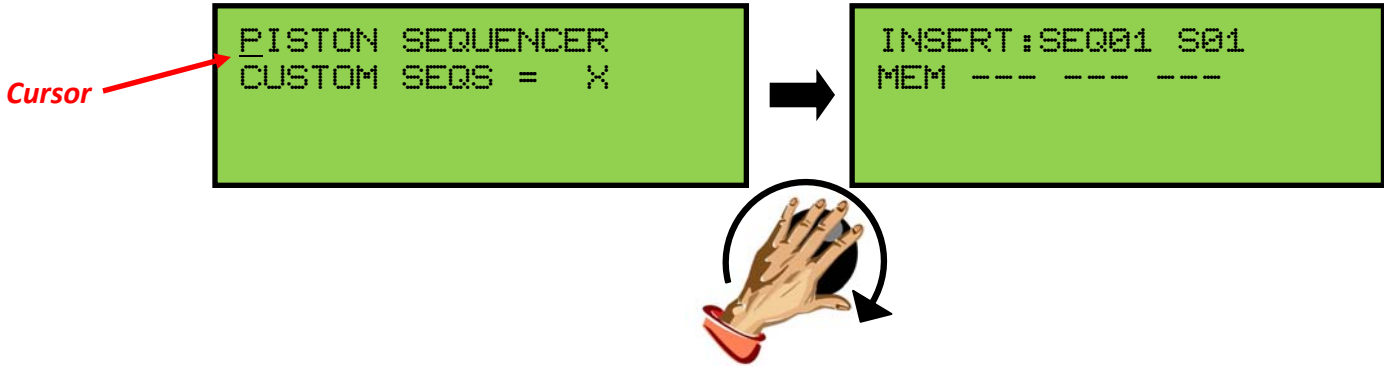

Note: If the organ does not contain any custom sequences, the editing window will automatically default to the INSERT mode. However, if the organ does contain custom sequences, the editing window will default to the EDIT mode.

To enter the INSERT mode, press the **CURSOR** button to position the cursor on the editing function.

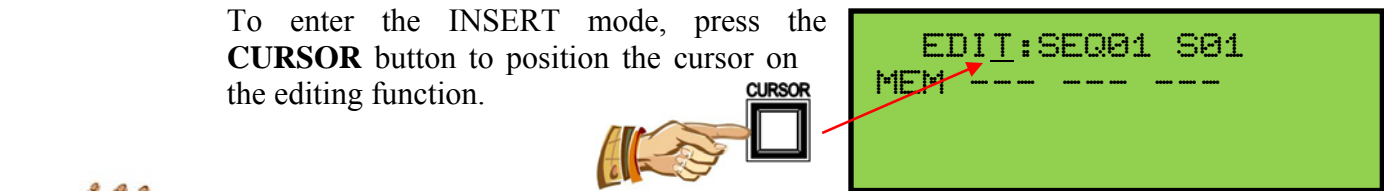

Turn the **ROTARY DIAL** to select "INSERT" mode.



There are several available data fields within the Custom Sequence editing windows. The organist has access to the custom sequence number, step position number, capture memory level, piston division assignment and piston number.

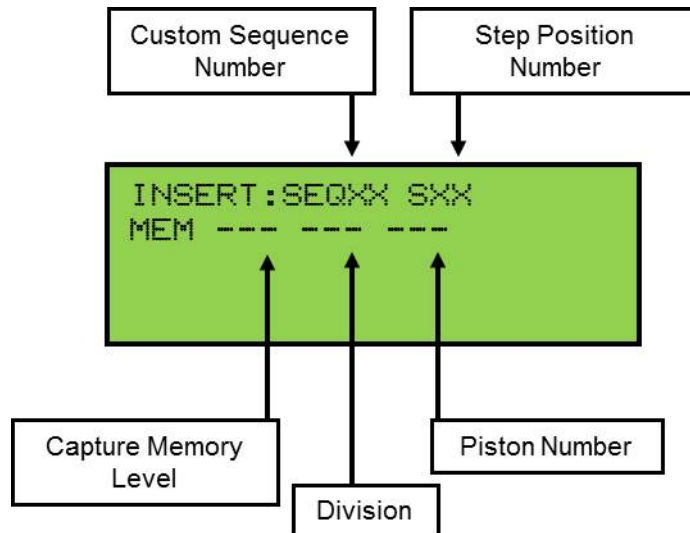



Use the **CURSOR** button to position the cursor on a data field and the **ROTARY DIAL** to select a desired value. Blank positions indicate the specified Sequence and Step have no programmed contents. Enter values for the Seq#, Step#, capture memory level, division and piston number.

```
INSERT:SEQ01 S01
MEM 1 Gen 8
```



Once the desired values have been set, use the **SET** and **MEMORY** buttons to save the data to the selected step position. "DONE!" will briefly flash on the display to indicate the current step position has been successfully saved to memory. Continue adding steps and sequences as desired.

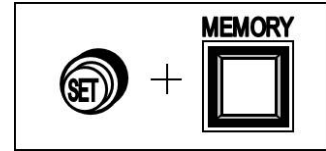

```
INSERT:SEQ01 S01
      DONE!
```

In addition to creating a new piston sequence, the INSERT mode can add step positions into an existing piston sequence. To do this, using the CURSOR button/ROTARY DIAL, select an existing piston sequence number and step position number to insert a new step.

Note: If the step position number is positioned on the last step of the selected piston sequence, no higher step number may be selected. The step will be appended to the end of the piston sequence.

Select the desired values for the capture memory level, division and piston number. Use the **SET** and **MEMORY** buttons to save the selected data. "DONE!" will briefly flash on the display to indicate the step position has been successfully saved to memory.

Note: Inserting and saving a new step position will move all subsequent steps within the piston sequence up by one step position.



Important! Do not use the INSERT mode to edit a step position. INSERT will only add steps into a piston sequence at the selected step position.

EDITING AN EXISTING STEP POSITION

To enter the EDIT mode, press the **CURSOR** button to position the cursor on the editing function.



```
INSERT:SEQ01 S01
MEM 1 Gen 8
```



Turn the **ROTARY DIAL** to select "EDIT" mode.

```
EDIT:SEQ01 S01
MEM 1 Gen 8
```

Using the CURSOR button/ROTARY DIAL, select a piston sequence number and step position number to be changed. Then, select and edit the desired capture memory level, division and piston number. Use the **SET** and **MEMORY** buttons to save the edited data. "DONE!" will briefly flash on the display to indicate the edited step position has been successfully saved to memory.

DELETING A SEQUENCE OR SINGLE STEP POSITION

To enter the DELETE mode, press the **CURSOR** button to position the cursor on the editing function.

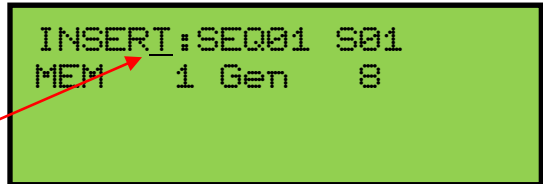

Turn the **ROTARY DIAL** to select "DELETE" mode.



Using the CURSOR button/ROTARY DIAL, select a piston sequence number and/or step position number that is to be deleted.



Important! The cursor position determines whether a single step position or an entire piston sequence is deleted.

- If an entire piston sequence is to be deleted leave the cursor over the piston sequence number field.
- If a step position within a piston sequence is to be deleted leave the cursor over the step position field.

Check the CURSOR POSITION!! DELETE cannot be undone once it has been performed.

Use the **SET** and **MEMORY** buttons to delete the selected data. "DONE!" will briefly flash on the display to indicate the selected data has been deleted successfully.

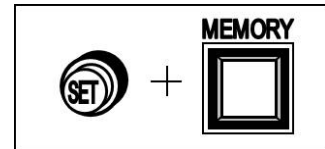

Note: Deleting a step position within the middle of a piston sequence will cause all subsequent steps to shift down by one step position. Empty step positions are not allowed.

Note: Deleting all piston sequences from memory will cause the organ to automatically enter the INSERT mode while within the editing window.

SHOWING/PREVIEWING A PISTON SEQUENCE

To enter the SHOW mode, press the **CURSOR** button to position the cursor on the editing function.



```

EDIT:SEQ01 S01
MEM 1 Gen 8
    
```

Turn the **ROTARY DIAL** to select "SHOW" mode.

```

SHOW:SEQ01 S01
MEM 1 Gen 8
    
```



Using the CURSOR button/ROTARY DIAL, first select a piston sequence number and then a step position to be viewed. Use the ROTARY DIAL to change the step position number. As the step position counter changes the selected step position's programmed data will appear within the display and will also be reflected on the organ's stop controls.

The Show mode is provided as a "shortcut". Instead of exiting out of the editing window to view a piston sequence, the contents of piston sequences may be viewed from within the edit window. The Show mode displays step positions and programmed data within the display. Stop controls operate showing the registration saved for each step position. The organist can toggle back and forth between the editing modes by using the CURSOR button and ROTARY DIAL to make changes to the piston sequence.

USING A CUSTOM PISTON SEQUENCE

To use a custom piston sequence, make sure that the Custom Piston Sequence mode is selected and then return to the *Main Window* function (*see Sections A-2 and C-7*). The display will indicate the Custom Piston Sequence mode is selected as well as the piston sequence number and step position.

From here, the organist can select a custom piston sequence to use and step position. The capture memory level and piston display will reflect the programmed data within the selected step position number.

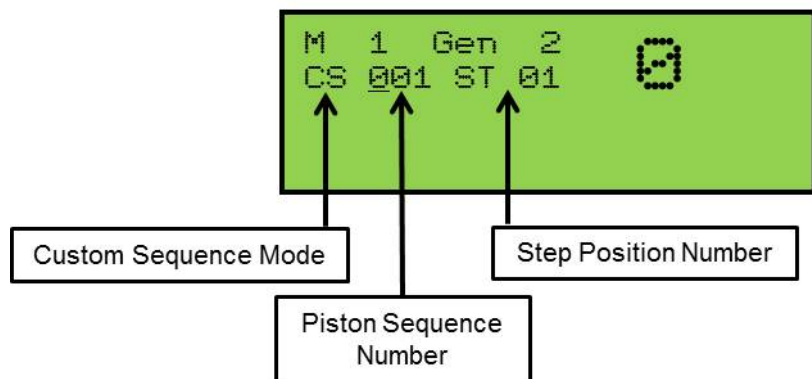

To select a piston sequence number, press the **CURSOR** button to position the cursor on the piston sequence number.



```

M 1 Gen 2
CS 001 ST 01
    
```



Then, turn the **ROTARY DIAL** to select a piston sequence number.

To select a step position, press the **CURSOR** button to position the cursor on the step position number.

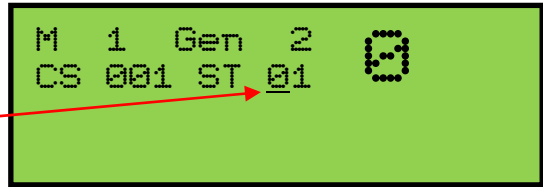

Then, turn the **ROTARY DIAL** to select a starting step position. To begin the piston sequence at the selected step position, press the “+” or “—” piston/toe stud. The capture memory level and piston display will reflect the programmed data within the displayed step position number and the registration will be reflected on the organ’s stop controls.

Use the “+” and “—” pistons/toe studs to step up or down through the piston sequence. If at any time a different piston/toe stud is selected out of the sequence, the piston display will indicate that a piston/toe stud was selected which is not within the piston sequence (*see illustration*). Selecting a piston/toe stud out of sequence will not change the step position counter value, only the programmed registration of the selected piston/toe stud will be reflected on the organ’s stop controls. To continue stepping through the piston sequence simply press the “+” or “—” piston/toe studs and the piston sequence will resume at the next programmed step position based on the piston/toe stud pressed.

Out of Sequence

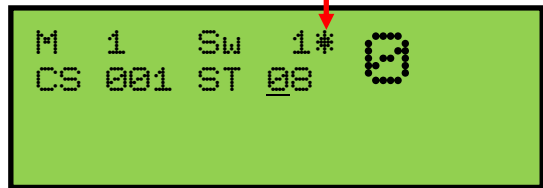

C. MIDI FUNCTIONS

This section explains the MIDI capabilities of your Allen Organ. Knowledge of this section is **not** required for everyday use of the organ, normal service playing, or use of Allen SmartMIDI™ devices. This information's usefulness will ultimately be determined by your needs, along with the type and capabilities of any external MIDI devices you choose to use--e.g., sequencers, voice/sound modules and external MIDI keyboards. The MIDI topics covered by this manual are limited in scope. You need to understand the terms MIDI IN, OUT and THRU and their basic functions. To increase your understanding of MIDI and its capabilities you will need to read books that describe how to use MIDI. See Section D later in this manual for more information regarding MIDI.

Note: You must also consult the owner's manual that covers the external MIDI device(s) you are using for more details of their operation.

1. Standard MIDI Channel Assignments

These are the Allen Organs' standard MIDI channels settings:

L-332 (DK included)		
Channel		Organ Division
1	=	Swell
2	=	Great
3	=	Pedal
4	=	Positiv
8	=	General

Note: The MIDI Base Channel always resets to Channel 1 whenever the organ is turned on (*see section C-5*).

2. Selecting Program Change Modes

Program change modes establish how MIDI program changes will be sent from the organ when a piston is pressed and what the resulting display will be within the GeniSys™ Controller LCD. Once a particular program change mode is selected, the organ will retain this same program change mode (even when the organ is turned off) until a new program change mode is selected. These three mode options determine how the organ sends program change information to MIDI devices.

Selecting a Program Change Mode

Advance to the 'PROG CHG' window function (*see Section A-2*). It will display:

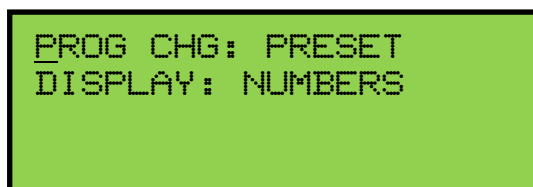

```
PROG CHG: PRESET
DISPLAY: NUMBERS
```

Press the **CURSOR** button until the cursor is positioned on the Program Change mode value.



Turn the **ROTARY DIAL** to select either "Preset", "User" or "No" modes.



Important! You must understand how to operate and when to use each of these modes before you change them!



PRESET Mode: This mode causes the organ to send a program change number equal to the piston number that is pressed. Preset mode also allows the organ to transmit the capture memory level value whenever the capture memory level is changed or whenever the CANCEL piston is pressed. The General Pistons will send program changes 1-10 on MIDI Channel 8, the organ's General Piston control channel. The Divisional Pistons for each division will send program changes on the respective MIDI channels as shown on the previous page. For example, Swell Piston 1 will send Program Change 1 on MIDI Channel 1. Great Piston 2 will send Program Change 2 on MIDI Channel 2, etc. (See Section C-6).

USER Mode: In this mode, the organ is capable of sending any program change number on any piston that will select voices, change banks, or change program "patch" numbers on another MIDI device. Any MIDI program change number from 1 through 127 can be assigned to any General or Divisional Piston (blank or no digit may also be selected). Any MIDI bank switch number between 0 and 127 can be assigned to any Divisional Piston. As in PRESET mode, General Pistons will send program change information on MIDI Channel 8. Divisional Pistons will send program change information on their respective MIDI channels. (See Section C-6)

Note: The capture memory level value is not transmitted while in USER mode.

NO Mode: With this mode selected, NO program change information is either transmitted or received.

3. General MIDI Sound Names or Program Numbers

The GeniSys™ Controller™ can display MIDI program changes as either MIDI program numbers or as General MIDI sound names while in USER Program Change mode. First, make sure the Program Change mode is set to USER (see section C-2). Press the **CURSOR** button until the flashing cursor is positioned on the Display mode value.



Then, turn the **ROTARY DIAL** to change and select one of the two modes.

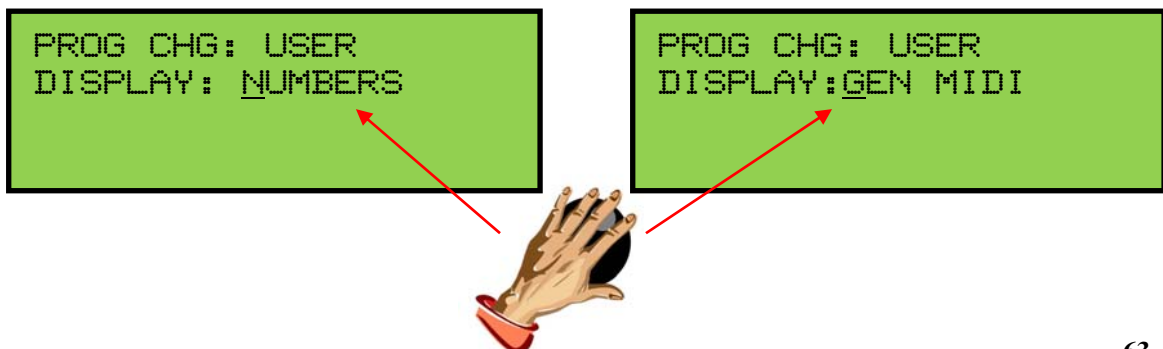

General MIDI Sound Names

With General MIDI mode selected, the 'PROG CHG' window will display:

```
PROG CHG: USER  
DISPLAY:GEN MIDI
```

Advance to the next window function then press a piston to view the sound names for any General MIDI device. The next window will display:

```
MIDI PROG CHG
```

When you press a General piston, the GeniSys™ Controller™ will display the General MIDI sound name which corresponds to the MIDI program change selected. For example, press General Piston 1. The GeniSys™ Controller™ will display the MIDI program change name assigned to that piston.

```
GEN 1  BANK  0  
P:Ac Grand Piano
```

Note: In some cases, the General MIDI sound name may be abbreviated.

You can change either the Bank value or Program Change name at any time by positioning the cursor on the value you wish to change.



```
GEN 1  BANK  0  
P:Ac Grand Piano
```

```
GEN 1  BANK  0  
P:Ac Grand Piano
```



Then, turn the **ROTARY DIAL** to change the selected value. *Section C-4* explains this procedure in more detail.

1. Any Bank value between 0 and 127 may be selected.
2. Any General MIDI sound name may be selected and assigned to a piston. See *Section E-4* later in this manual for a list of available General MIDI sound names.

Program Numbers:

With NUMBERS selected as the display mode, the 'MIDI PROG CHANGE' window function will display:

```
GEN 1   BANK   0
P:XXX
```

With PRESET selected as the program change mode, press a General piston. The GeniSys™ Controller will display the same MIDI program change number as the associated piston pressed. For example, pressing General Piston 1 will display:

```
GEN 1   BANK   0
P:  1
```



Important! The MIDI program change number will be displayed in PRESET mode, no matter if NUMBERS or GEN MIDI is selected. USER mode must be selected to view the GENERAL MIDI sound names. USER mode must also be selected to be able to assign MIDI program change numbers higher than the highest number of General pistons.

With USER selected as the program change mode, along with NUMBERS as the display mode, “- - -” (OFF) or any program change number from 1 through 127 may be assigned to any General piston.

There may be a number or “- - -” following the “P:”. This “P:” represents the Program Change Number and does not stand for PRESET in this window. If there is “- - -” following “P:” this means that the “ZERO” Program Change Number will be sent from the associated piston.

To change the MIDI program change numbers, press the **CURSOR** button until the cursor is positioned on the program change number value.



```
GEN 1   BANK   0
P:  1
```



Turn the **ROTARY DIAL** to change the program number value. *Section C-4* explains this procedure in more detail.

Note: The Allen Organ uses MIDI Program Change Zero as a message for "MIDI OFF."



Important! MIDI Program Change 1 corresponds to the General MIDI sound "Acoustic Grand Piano." Some MIDI devices do not use MIDI Program Change Zero as MIDI OFF. Consequently, Program Change Zero, (" - - " *in the window*) when sent from the organ, will correspond to Program Change 1 on those MIDI devices, MIDI Program Change 1 will correspond to MIDI Program Change 2, etc. You must understand how the connected MIDI device responds to MIDI program changes to know which program change numbers to assign to a General piston to be able to get a selected voice on a given MIDI device. Refer to the specific MIDI device's owner's manual for more information about MIDI program change response.

4. Assigning MIDI Program Changes to Organ Pistons

This function allows the organist to select any voice on an external MIDI device by pressing any General piston on the organ. The "USER" program change mode must be selected (*See Section C-2*). Advance to the 'MIDI PROG CHANGE' window function (*see Section A-2*).

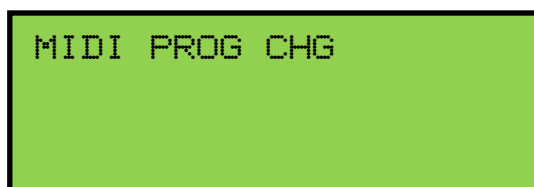

For this example press the General Piston 2. The display will change to:



The LCD will display the piston pressed and the MIDI program number being transmitted by that piston.



To change the value transmitted, press the **CURSOR** button to position the cursor on the program change number value. Turn the **ROTARY DIAL** to change the program number value. Any program number of (1-128) may be selected. (*See Section C-1*).



Note: Once a MIDI program change number is assigned to a piston, that program number will remain assigned to that piston even if the organ has been turned off.



Important! Once MIDI program change programming is complete the organist must exit the piston programming window function, by using the **SET** and **CANCEL** pistons (*see Section A-2*), for any changes to take effect.

5. MIDI Bank Selecting

Many MIDI devices permit access to a variety of sounds in addition to the General MIDI sounds. Normally these additional sounds are stored in groups called BANKS. A BANK in MIDI terminology means a group of voices or sounds. There are two levels of banks. One level offers two choices, High Bank and Low Bank. Each of these, High Bank and Low Bank, has as sub-groups other level of banks, BANK Numbers.

MIDI devices can have as many as 128 sounds/voices per BANK Number. There can also be 128 available BANK Numbers (Ø through 127). With 128 BANK Numbers, each could contain up to 128 voices/sounds, for a total of 16,384 sounds. For an easier explanation, think of these BANK Numbers as floors or stories in a tall building. Each floor would contain 128 rooms and each room could then contain 128 voices.

There are MIDI devices that are High Bank and Low Bank compatible. It would be possible for these MIDI devices to have as many as (128 X 128 X 2 = 32,768 voices/sounds) 128 voices/sounds in each of the 128 BANK Numbers, in each of the High and Low Banks. Most MIDI devices do not use all of the locations available. It would be very expensive as well as difficult to remember the address for each sound location. There are also MIDI devices that offer only General MIDI sounds/voices. These General MIDI devices may operate using High Bank or Low Bank, but only the sub-group Ø Bank Number is used to store the 128 General MIDI sound settings. Allen Organs are able to access any of the Banks and therefore can communicate with all MIDI devices.

Note: You MUST know the capabilities of, and understand how to operate, the MIDI device you intend to use with the organ!

Selecting High Bank or Low Bank:

Advance to the 'MIDI BASE CHANNEL' window function (*see Section A-2*).

```
MIDI BASE CH: 1
BANK: Low
```

Press the **CURSOR** button until the cursor is positioned on the BANK value.

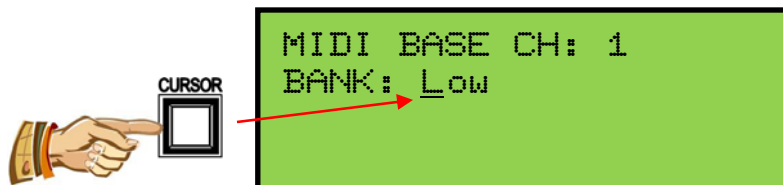

Turn the **ROTARY DIAL** to select either HIGH or LOW Bank priority.

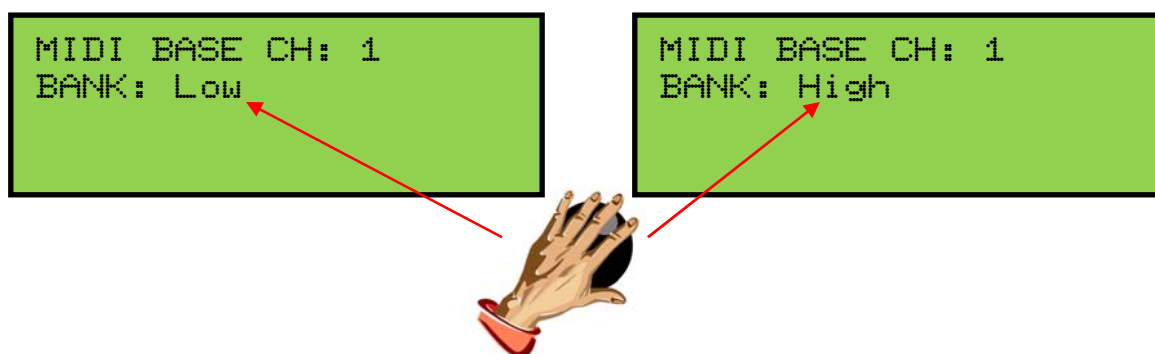

Selecting MIDI Bank Numbers:

Bank Numbers are assignable in the same way that MIDI Program Numbers are (See Section C-3). You **MUST** have USER mode selected before assigning Bank numbers! Advance to the 'MIDI PROG CHANGE' window function (see Section A-2).



MIDI PROG CHG

For this example press the General piston #1. The display will change to:



GEN 1 BANK 0
P: 1

The window will display the piston pressed, the MIDI BANK Number, and the program number being sent by that piston.

Press the **CURSOR** button until the cursor is positioned on the MIDI Bank number value. Turn the **ROTARY DIAL** to change the MIDI BANK number value.

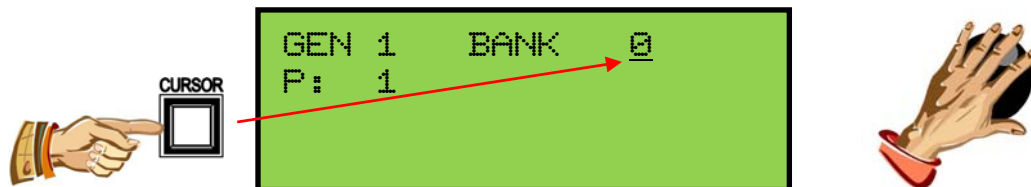

Note: Refer to the Bank selection/program number chart in the owner's manual for the external MIDI device you are using to be sure you are using a valid Bank number value.

Note: Once you have assigned a MIDI BANK Number to a piston, that number will remain assigned to that piston even if the organ has been turned off.



Important! Once MIDI Bank change programming is complete the user must exit the piston programming window function, by using the **SET** and **CANCEL** pistons (see Section A-2), for any changes to take effect.

6. Changing the MIDI Base Channel

This function allows you to change the setting of the MIDI Base Channel. The Base Channel is a reference point to establish the positioning of the other 15 MIDI channels on the organ. On Allen Organs, the Base Channel equals the Swell Division's channel of transmission (i.e., if the Base Channel = 1, then the Swell Channel = 1, if the Base Channel = 2, then the Swell Channel = 2, etc.). Moving the Base Channel allows you to shift the organ's range of MIDI channels, this is helpful when reassigning an external MIDI device from one organ division to another.



Important! The Base Channel always resets to Channel 1 whenever the organ is turned on.

Advance to the 'MIDI BASE CH' window function (*see Section A-2*).

```
MIDI BASE CH: 1
BANK: Low
```



Press the **CURSOR** button until the cursor is positioned on the MIDI Base Channel value. Turn the **ROTARY DIAL** to change the MIDI Base Channel value. All functions associated with a particular division will transmit and receive on its assigned channel. For example, MIDI Channel 1 is normally assigned to the Swell Division and the Swell Manual. Therefore, keying velocity or on/off messages will be transmitted and received on MIDI Channel 1 (*See Section C-1 for Allen MIDI Channel Assignments*).



If the Base Channel is set to 2, all of the channels will shift higher by one. Now; Swell = 2, Great = 3, Pedal = 4 and the General Pistons = 9.

Note: MIDI Channel numbers will wrap, i.e. channel numbers go only to 16 and will then repeat to 1.

7. MIDI Expression Settings

Advance to the 'MIDI EXPRESSION' window function (*see Section A-2*).

```
MIDI EXPRESSION
POLY - VOLUME
```



There are four modes for transmitting expression data via MIDI. To select an expression mode, press the **CURSOR** button until the cursor is positioned on the expression setting value (line 2) of the display.

Turn the **ROTARY DIAL** to select one of the four different expression modes.

Note: The default expression mode setting is always POLY-VOLUME.



```
MIDI EXPRESSION
POLY - VOLUME
POLY - VELOCITY
SWELL - VOLUME
NO EXPRESSION
```

POLY-VOLUME — This is the normal expression mode setting where the expression data is distributed among the appropriate MIDI channels.

POLY-VELOCITY — This setting should be selected if you are using a percussion-type voice from a sound module or an external MIDI keyboard. For example, if a digital piano sound were played from the organ keyboard through MIDI Channel 1, the piano could be made to sound more realistic. By opening the Swell expression shoe, the piano strings would appear to be struck harder than when the Swell pedal was in the closed position.



Important! This mode setting should only be used if your Allen Organ does not contain velocity sensitive keying.

Note: In POLY-VELOCITY mode, all expression information is sent in key velocity form. Changes in velocity will occur only when a new key is struck. Consequently, if you change the position of the Swell pedal after a key is struck there will be no change in velocity until a new key is struck. Use this mode only when a velocity-sensitive external MIDI device is connected. If this mode is selected when recording to a sequencer, the expression on the organ will not function when playing back from the sequencer.

SWELL-VOLUME — This mode setting causes MIDI expression data to be sent only on the Swell MIDI channel. Some early sequencers can only interpret one volume message.

NO EXPRESSION — No MIDI expression (volume) data sent.

8. MIDI Sustain Kick Switch (optional)

A lever located to the left of the expression shoe and controlled by the organist's foot, operates MIDI sustain. This function can be assigned to any one of or all of the instrument's manuals. Advance to the 'MIDI SUSTAIN' window function (*see Section A-2*).

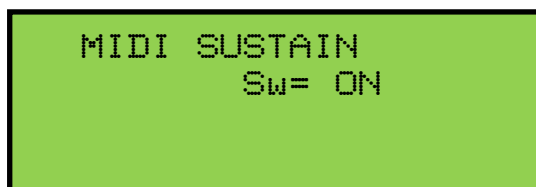

To select an organ keyboard (manual), press the **CURSOR** button until the cursor is positioned on the manual abbreviation.



Turn the **ROTARY DIAL** to select an organ keyboard.

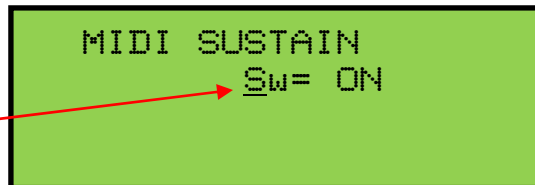

To turn the MIDI Sustain function on/off on the selected manual, press the **CURSOR** button to position the cursor on the MIDI Sustain value.

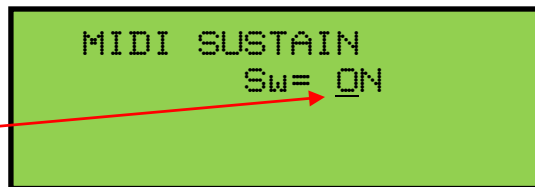

Turn the **ROTARY DIAL** to turn the selected manual **ON/OFF**.

OFF will not allow MIDI Sustain messages to be transmitted, **ON** will allow MIDI sustain messages to be transmitted on a given keyboard (manual) or MIDI channel. For example, when a **PIANO** voice in an external MIDI device (voice module) is selected and the MIDI sustain for that given MIDI channel (division) is turned **ON**, and the foot controlled sustain lever is actuated, the piano sound will slowly decay.

9. Organ Local Off

Organ Local Off is a function that allows the user to “virtually” disconnect the organ’s keyboards, pedalboard and pistons from the organ’s tone generation and capture system. In essence, the organ is transformed into a sophisticated multi-manual MIDI controller.

To enable/disable the Organ Local Off function, advance to the ‘ORGAN LOCAL OFF’ window function (see Section A-2).

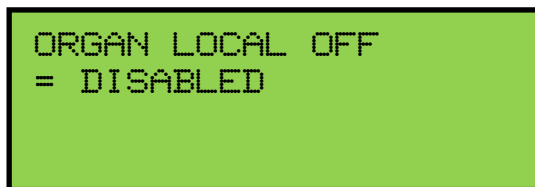

To enable/disable the Organ Local Off function, press the **CURSOR** button to position the cursor on the Local Off control value.



Turn the **ROTARY DIAL** to change the enable/disable value.

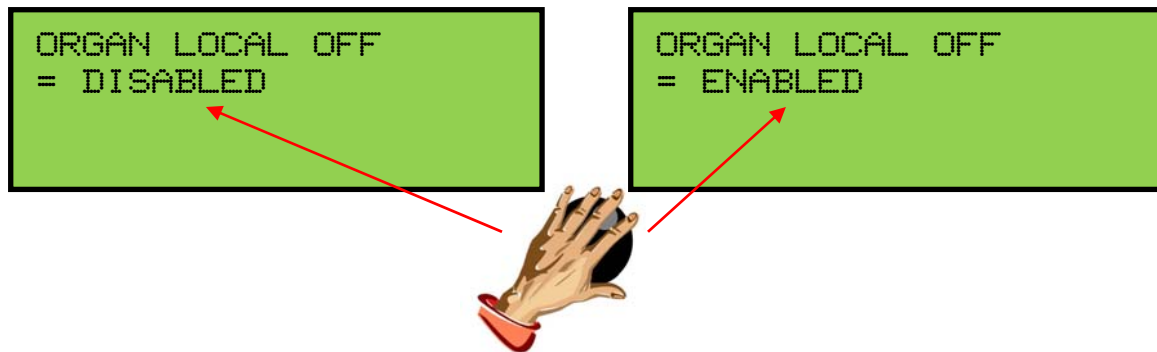

Note: When Organ Local Off is enabled, the MIDI stops do not need to be on to play the external MIDI device(s).

10. Transmission/Reception of Individual Stop Data

This function allows the organist to turn on/off the transmission and reception of individual stop data, known in MIDI terminology as "Non-Registered Parameters". In some cases individual stop data (on/off) from the organ may conflict with data from an external MIDI device. When this occurs, select the "OFF" position.

Note: Piston changes will still be transmitted and received, because they are classified as MIDI program changes.

Advance to the 'TRANSMIT / RECEIVE STOPS' window function:

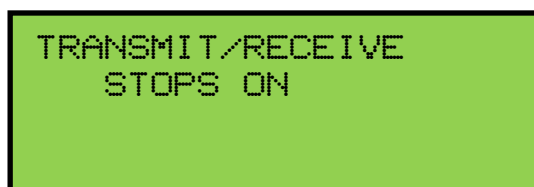

To change the on/off status of the Transmit/Receive Stops function, press the **CURSOR** button to position the cursor on the control value.

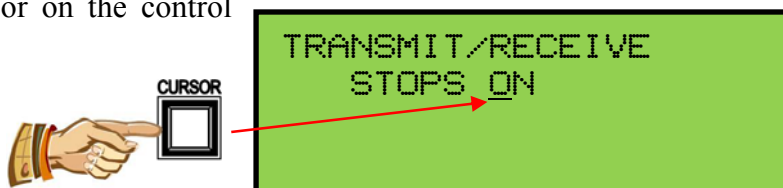

Turn the **ROTARY DIAL** to change the transmit/receive status on or off.

D. MIDI GUIDE

1. MIDI for Organists

The term MIDI is an acronym for Musical Instrument Digital Interface. Since 1983, MIDI has been adopted by the music industry as a standard means of communication between digital musical devices enabling devices of different types and manufacturers to communicate. MIDI by itself will not make a sound. It is not necessary to understand all of the technical aspects of MIDI in order to take advantage of the benefits it offers. It is important to explore the potential MIDI holds for musicians, as well as the various MIDI applications available today.

Types of MIDI Devices

MIDI devices fall into two categories.

1. The first category consists of musical instruments such as organs and synthesizers that transmit and receive MIDI data.
2. The second category includes controllers and processors that, as their name implies, can transmit, receive or manipulate MIDI data, but do not necessarily produce sound themselves. Sequencers, which are MIDI recording devices, fall into this category. Although the technical nature of their recording and editing processes differs from those of a tape recorder, many operate in similar fashion. Most are equipped with record, playback, fast forward and reverse controls that function in the same way as their tape recorder counterparts.

Types of MIDI Data

There are several types of MIDI messages that can be sent from one device to another. The most common is keying information, allowing one device to sense which keys have been played on another device. This means an organ equipped with MIDI can send information to other MIDI devices, e.g., synthesizers or sequencers, and can play those devices simultaneously or record information to be played back later.

Allen Organs incorporate an advanced MIDI system allowing the transmission and reception of all types of MIDI information (velocity keying, volume, sustain, registrations and much more). It is even possible to control several devices from one manual simultaneously, or control a different device from each manual of the console.

MIDI as a Practice Tool

For the organist/choir director, the MIDI organ console and sequencer are valuable rehearsal tools for both choral and organ works. Anthem accompaniments may be recorded in advance and played back by the sequencer during choir rehearsal. The director, freed from the role of accompanist, can focus entirely on directing the choir. The sequencer can play the music back at a slower tempo without affecting pitch or at a lower pitch without affecting tempo, features that are useful in rehearsing difficult choral passages.

If the sequencer allows multi-tracking, each vocal section's part may be recorded on a different track, and then played back individually, or in any combination, for more flexibility. Multi-tracking can also be used in teaching and learning new organ works. The teacher may record each hand or pedal part on a different track, allowing the student to "mute" or turn off any part being practiced while still being able to hear the sequencer play the rest of the composition. The student's ability to hear the piece in its entirety from the earliest stage of learning a composition, and to become aware of the interrelationship of its voices, is especially valuable in learning contrapuntal works.

MIDI as a Registration Tool

In some churches and auditoriums it is difficult to judge the effectiveness of a registration from the organ console. Due to the acoustics of the room, or positioning of the console, the sound of the instrument may be different when listened to from the congregation's or audience's vantage point. MIDI allows the organist to evaluate registrations by recording the music using a sequencer, and then listening from different locations in the room during the music's playback.

Other MIDI Uses

MIDI has created new possibilities for the organist. The ability of the organ console to control external keyboards or sound modules puts an ever-increasing array of non-traditional sounds at the organist's fingertips. A superior degree of control is made possible by the flexibility of an organ console. The ability to record MIDI data using a sequencer opens a variety of new possibilities during practice and performance situations.

Computer software programs are also available that allow musicians to play MIDI devices connected to a computer, and have their performance printed as conventional five-line musical notation. Because MIDI is an industry-wide standard, today's MIDI instruments will be compatible with tomorrow's MIDI innovations.

2. Allen's Exclusive MIDI System

Allen Organs feature an advanced MIDI system with increased flexibility. This system provides a comprehensive interface between MIDI sound modules, such as the Allen Ensemble™, and digital sequencers such as the Allen MIDI Assistant™. Two MIDI Out ports, one switched and one unswitched, allow unprecedented control over external MIDI devices attached to the organ.

Under normal circumstances, MIDI sound modules should be connected to the switched MIDI port, labeled MIDI OUT 2. Doing so allows the organist to disable the sending of MIDI keying data from the organ to the sound module. Devices such as MIDI sequencers should be connected to the unswitched MIDI port, labeled MIDI OUT 1, eliminating the necessity of having to draw the MIDI stop controls before recording a digital sequence. The drawing below illustrates the proper procedure for connecting the Allen Ensemble™ and Allen MIDI Assistant™ to an Allen Organ.

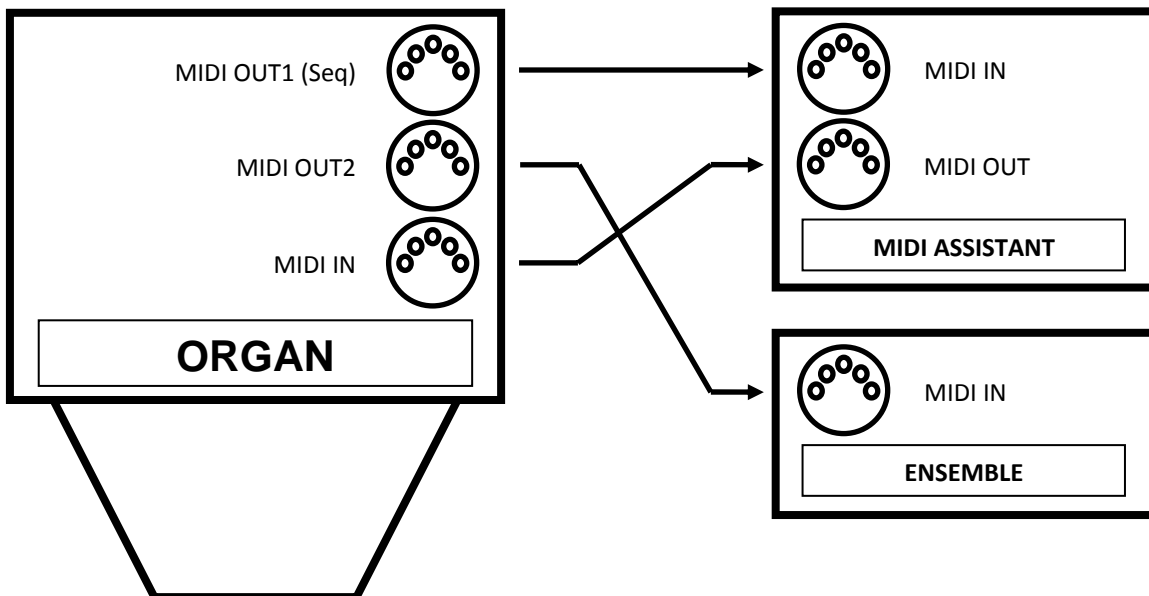

3. MIDI Transmission Channels

MIDI information may be transmitted on several different channels simultaneously. This allows many channels of information to be sent through one cable and used independently from one another, similar to the way many television broadcasts can be sent through one cable. In order to receive the intended information, a MIDI device must be tuned to the same channel as the device that is sending the information.

Your Allen Organ transmits MIDI information on several channels. When external MIDI devices are connected to the organ, it is important to make sure that the devices' channels of transmission and reception match the MIDI channels of the Allen Organ divisions to which they are assigned.

MIDI Program Change Messages are transmitted from the organ's General Pistons on MIDI Channel 8. These program change messages can be used to change the settings of MIDI sound modules or synthesizers that are connected to the organ. Please consult the owner's manual of your MIDI device(s) for more information on how MIDI Program Change Messages are handled by that particular device.

In addition to keying and divisional registration information, MIDI Volume Messages are sent on the individual MIDI channels for each division of the organ. These volume messages are controlled by the expression shoe. In this manner, the volume of connected MIDI devices may be controlled.

Please consult the owner's manual of your MIDI device(s) for more information on how MIDI Volume information is handled by that device. If any external MIDI device is used to transmit information to the Allen organ, the same assignment of MIDI channels must be used as described elsewhere in this manual.

4. GENERAL MIDI SOUND SET

1. Acoustic Grand Piano
2. Bright Acoustic Piano
3. Electric Grand Piano
4. Honky-tonk Piano
5. Rhodes Piano
6. Chorused Piano
7. Harpsichord
8. Clavinet
9. Celesta
10. Glockenspiel
11. Music Box
12. Vibraphone
13. Marimba
14. Xylophone
15. Tubular Bells
16. Dulcimer
17. Hammond Organ
18. Percussive Organ
19. Rock Organ
20. Church Organ
21. Reed Organ
22. Accordion
23. Harmonica
24. Tango Accordion
25. Acoustic Guitar (nylon)
26. Acoustic Guitar (steel)
27. Electric Guitar (jazz)
28. Electric Guitar (clean)
29. Electric Guitar (muted)
30. Overdriven Guitar
31. Distortion Guitar
32. Guitar Harmonics
33. Acoustic Bass
34. Electric Bass (finger)
35. Electric Bass (pick)
36. Fretless Bass
37. Slap Bass 1
38. Slap Bass 2
39. Synth Bass 1
40. Synth Bass 2
41. Violin
42. Viola
43. Cello
44. Contrabass
44. Contrabass
45. Tremolo Strings
46. Pizzicato Strings
47. Orchestral Harp
48. Timpani
49. String Ensemble 1
50. String Ensemble 2
51. Synth Strings 1
52. Synth Strings 2
53. Choir Aahs
54. Voice Oohs
55. Synth Voice
56. Orchestra Hit
57. Trumpet
58. Trombone
59. Tuba
60. Muted Trumpet
61. French Horn
62. Brass Section
63. Synth Brass 1
64. Synth Brass 2
65. Soprano Sax
66. Alto Sax
67. Tenor Sax
68. Baritone Sax
69. Oboe
70. English Horn
71. Bassoon
72. Clarinet
73. Piccolo
74. Flute
75. Recorder
76. Pan Flute
77. Bottle Blow
78. Shakuhachi
79. Whistle
80. Ocarina
81. Lead 1 (square)
82. Lead 2 (sawtooth)
83. Lead 3 (calliope lead)
84. Lead 4 (chiff lead)
85. Lead 5 (charang)
86. Lead 6 (voice)
86. Lead 6 (voice)
87. Lead 7 (fifths)
88. Lead 8 (brass + lead)
89. Pad 1 (new age)
90. Pad 2 (warm)
91. Pad 3 (polysynth)
92. Pad 4 (choir)
93. Pad 5 (bowed)
94. Pad 6 (metallic)
95. Pad 7 (halo)
96. Pad 8 (sweep)
97. FX 1 (rain)
98. FX 2 (soundtrack)
99. FX 3 (crystal)
100. FX 4 (atmosphere)
101. FX 5 (brightness)
102. FX 6 (goblins)
103. FX 7 (echoes)
104. FX 8 (sci-fi)
105. Sitar
106. Banjo
107. Shamisen
108. Koto
109. Kalimba
110. Bagpipe
111. Fiddle
112. Shanai
113. Tinkle Bell
114. Agogo
115. Steel Drums
116. Woodblock
117. Taiko Drum
118. Melodic Tom
119. Synth Drum
120. Reverse Cymbal
121. Guitar Fret Noise
122. Breath Noise
123. Seashore
124. Bird Tweet
125. Telephone Ring
126. Helicopter
127. Applause
128. Gunshot

APPENDIX A: MIDI IMPLEMENTATION CHART

FUNCTION		TRANSMITTED	RECEIVED
Basic Channel	Default	1 – 16	1 – 16
	Changed	1 – 16	1 – 16
Mode	Default	3	3
	Messages	X	X
	Altered	X	X
Note Number		O (1 – 127)	O (1 – 127)
Velocity	Note ON Note OFF	9nH, v = 1 – 127 9nH, v = 0	9nH, v = 1 – 127 9nH, v = 0
Aftersustain	Keys	X	X
	Channels	X	X
Pitch Bend		O	O
Control Change	0 (bank select)	O	X
	6 (Data MSB)	O	O
	7 (volume)	O	O
	64 (sustain)	O	O
	66 (sostenuto)	O	O
	98 (NRPN: LSB)	O	O
99 (NRPN: MSB)	O	O	
Program Change		O (1 – 127)	O (1 – 127)
System Exclusive		O	O
System Common		X	X
System Real Time		X	X
Aux Messages		X	X

Mode 1: Omni On, Poly
Mode 3: Omni Off, Poly

Mode 2: Omni On, Mono
Mode 4: Omni Off, Mono

O: Yes
X: No

APPENDIX B: HYMN PLAYER Song List

A Mighty Fortress	Doxology (w/Amen ending - 1 verse only)	Joyful, Joyful We Adore Thee	Savior, Like a Shepherd Lead Us
Abide with Me	Eternal Father, Strong to Save	Just As I Am, without One Plea	See Amid the Winter's Snow
Ah! Holy Jesus	Fairest Lord Jesus	Lead on O King Eternal	Shall We Gather at the River
Alas! And Did My Savior Bleed	Faith of Our Fathers	Let All Mortal Flesh Keep Silence	Silent Night, Holy Night
All Creatures of Our God and King	Fight the Good Fight	Lift Up Your Heads, Ye Mighty Gates	Songs of Thankfulness and Praise
All Glory, Laud, and Honor	For All the Saints	Lo, How a Rose E're Blooming	Spirit Divine, Accept Our Prayers
All Hail the Power of Jesus' Name - A	For the Beauty of the Earth	Lord, Speak to Me That I May Speak	Spirit of God, Descend Upon My Heart
All Hail the Power of Jesus' Name - B	Glorious Things of Thee Are Spoken	Lord, Who Throughout These Forty Days	Stand Up and Bless the Lord
All People That on Earth Do Dwell	Glory Be to the Father	Love Divine, All Loves Excelling - A	Sweet Hour of Prayer
All Praise to Thee, My God, This Night	Go to Dark Gethsemane	Love Divine, All Loves Excelling - B	Take My Life
All Things Bright and Beautiful	God of Grace and God of Glory	More Love to Thee, O Christ	The Church Is One Foundation
Alleluia! Sing to Jesus!	God of the Ages, Whose Almighty Hand	Morning Has Broken	The Day of Resurrection!
Amazing Grace	God Rest You Merry, Gentlemen	My Country, 'Tis of Thee	The First Noel
America	God with Hidden Majesty	My Hope Is Built on Nothing Less	The King of Love My Shepherd Is
Angels from the Realms of Glory	Good Christian Men, Rejoice	Near to the Heart of God	The Lord Is My Shepherd, I'll Not Want
Angels We Have Heard on High	Guide Me, O Thou Great Jehovah	Now Thank We All Our God	The Old Rugged Cross
As with Gladness Men of Old	Hark! The Herald Angels Sing	Now The Day Is Over	The Strife Is O'er
At the Cross Her Station Keeping	Holy God, We Praise Your Name	O Beautiful for Spacious Skies	Thine Is the Glory
At the Lamb's High Feast We Sing	Holy Spirit, Truth Divine	O Come and Sing Unto the Lord	This Is My Father's World
Away in a Manger - A	Holy, Holy, Holy	O Come, All ye Faithful	To God Be the Glory
Away in a Manger - B	How Brightly Beams the Morning Star	O Come, O Come Emmanuel	To Jesus Christ Our Sovereign King
Be Joyful, Mary	How Firm A Foundation	O God, Our Help in Ages Past	Wake, O Wake, and Sleep No Longer
Be Thou My Vision	How Great Thou Art	O Jesus, I Have Promised	We Gather Together
Beneath the Cross of Jesus	I Am the Bread of Life	O Little Town of Bethlehem	We Give Thee but Thine Own
Beyond the Sunset	I Love Thy Kingdom, Lord	O Love That Wilt Not Let Me Go	We Three Kings of Orient Are
Blessed Assurance, Jesus is Mine!	I Sing A Song of the Saints of God	O Master, Let Me Walk with Thee	What Child Is This
Blessed Jesus, at Your Word	I Sing the Mighty Power of God	O Perfect Love	What Wondrous Love Is This
Blessing and Honor	Immortal, Invisible, God Only Wise	O Sacred Head Now Wounded	When I Survey the Wondrous Cross - A
Blest Be the Tie That Binds	In Christ There Is No East or West - A	O Word of God Incarnate	When I Survey the Wondrous Cross - B
Break Thou the Bread of Life	In Christ There Is No East or West - B	O Worship the King	When in Our Music God Is Glorified
Breathe on Me, Breath of God	In the Cross of Christ I Glory	O, for a Closer Walk with God - A	When Morning Gilds the Skies
Christ the Lord Is Risen Today	In the Garden	O, for a Closer Walk with God - B	Where Cross the Crowded Ways of Life
Come, Christians, Join to Sing	It Came upon a Midnight Clear	O, for a Thousand Tongues to Sing	While Shepherds Watched Their Flocks - A
Come, Holy Spirit, Heavenly Dove	Jesus Christ Is Risen Today	On Jordan's Bank the Baptist's Cry	While Shepherds Watched Their Flocks - B
Come, Thou Almighty King	Jesus Loves Me!	Open My Eyes That I May See	Ye Servants of God, Your Master Proclaim
Come, Thou Fount of Every Blessing	Jesus Shall Reign Where'er the Sun	Open Now Thy Gates of Beauty	Ye Watchers and Ye Holy Ones
Come, Thou Long-Expected Jesus - A	Jesus, Lover of My Soul - A	Praise My Soul, the King of Heaven	
Come, Thou Long-Expected Jesus - B	Jesus, Lover of My Soul - B	Praise to the Lord, the Almighty	
Come, Ye Faithful, Raise the Strain	Jesus, Priceless Treasure	Rejoice, the Lord Is King	
Come, Ye Thankful People, Come	Jesus, The Very Thought of Thee	Rejoice, Ye Pure In Heart	
Creator of the Stars of Night	Jesus, Thou Joy of Loving Hearts	Ride On ! Ride On in Majesty	
Crown Him with Many Crowns	Joy to the World	Rock of Ages	

APPENDIX C: GNU PUBLIC LICENSE INFORMATION

NOTICE:

Portions (but not all) of the software contained within this device are covered by the GNU General Public License shown below. As Such, for a period of three years after the manufacture date, you are entitled to a machine-readable copy of the applicable source code for a fee that covers the distribution costs. You may request a copy by sending that request in writing to:

GENISYS GPL REQUEST
ALLEN ORGAN COMPANY LLC
150 LOCUST ST.
MACUNGIE, PA 18062

Please include your name, address, and phone number.

All portions not covered by the GNU GPL are to be considered Copyright (C) 2008, Allen Organ Company LLC, all rights reserved.

GNU GENERAL PUBLIC LICENSE
Version 2, June 1991
Copyright (C) 1989, 1991 Free Software Foundation, Inc.
51 Franklin St, Fifth Floor, Boston, MA 02110-1301 USA

Everyone is permitted to copy and distribute verbatim copies of this license document, but changing it is not allowed.

PREAMBLE

The licenses for most software are designed to take away your freedom to share and change it. By contrast, the GNU General Public License is intended to guarantee your freedom to share and change free software--to make sure the software is free for all its users. This General Public License applies to most of the Free Software Foundation's software and to any other program whose authors commit to using it. (Some other Free Software Foundation software is covered by the GNU Library General Public License instead.) You can apply it to your programs, too. When we speak of free software, we are referring to freedom, not price. Our General Public Licenses are designed to make sure that you have the freedom to distribute copies of free software (and charge for this service if you wish), that you receive source code or can get it if you want it, that you can change the software or use pieces of it in new free programs; and that you know you can do these things. To protect your rights, we need to make restrictions that forbid anyone to deny you these rights or to ask you to surrender the rights. These restrictions translate to certain responsibilities for you if you distribute copies of the software, or if you modify it. For example, if you distribute copies of such a program, whether gratis or for a fee, you must give the recipients all the rights that you have. You must make sure that they, too, receive or can get the source code. And you must show them these terms so they know their rights. We protect your rights with two steps: (1) copyright the software, and (2) offer you this license which gives you legal permission to copy, distribute and/or modify the software. Also, for each author's protection and ours, we want to make certain that everyone understands that there is no warranty for this free software. If the software is modified by someone else and passed on, we want its recipients to know that what they have is not the original, so that any problems introduced by others will not reflect on the original authors' reputations. Finally, any free program is threatened constantly by software patents. We wish to avoid the danger that redistributors of a free program will individually obtain patent licenses, in effect making the program proprietary. To prevent this, we have made it clear that any patent must be licensed for everyone's free use or not licensed at all. The precise terms and conditions for copying, distribution and modification follow.

GNU GENERAL PUBLIC LICENSE

TERMS AND CONDITIONS FOR COPYING, DISTRIBUTION AND MODIFICATION

1. This License applies to any program or other work which contains a notice placed by the copyright holder saying it may be distributed under the terms of this General Public License. The "Program", below, refers to any such program or work, and a "work based on the Program" means either the Program or any derivative work under copyright law: that is to say, a work containing the Program or a portion of it, either verbatim or with modifications and/or translated into another language. (Hereinafter, translation is included without limitation in the term "modification".) Each licensee is addressed as "you". Activities other than copying, distribution and modification are not covered by this License; they are outside its scope. The act of running the Program is not restricted, and the output from the Program is covered only if its contents constitute a work based on the Program (independent of having been made by running the Program). Whether that is true depends on what the Program does.
2. You may copy and distribute verbatim copies of the Program's source code as you receive it, in any medium, provided that you conspicuously and appropriately publish on each copy an appropriate copyright notice and disclaimer of warranty; keep intact all the notices that refer to this License and to the absence of any warranty; and give any other recipients of the Program a copy of this License along with the Program. You may charge a fee for the physical act of transferring a copy, and you may at your option offer warranty protection in exchange for a fee.
3. You may modify your copy or copies of the Program or any portion of it, thus forming a work based on the Program, and copy and distribute such modifications or work under the terms of Section 1 above, provided that you also meet all of these conditions:
 - a. You must cause the modified files to carry prominent notices stating that you changed the files and the date of any change.
 - b. You must cause any work that you distribute or publish, that in whole or in part contains or is derived from the Program or any part thereof, to be licensed as a whole at no charge to all third parties under the terms of this License.
 - c. If the modified program normally reads commands interactively when run, you must cause it, when started running for such interactive use in the most ordinary way, to print or display an announcement including an appropriate copyright notice and a notice that there is no warranty (or else, saying that you provide a warranty) and that users may redistribute the program under these conditions, and telling the user how to view a copy of this License. (Exception: if the Program itself is interactive but does not normally print such an announcement, your work based on the Program is not required to print an announcement.) These requirements apply to the modified work as a whole. If identifiable sections of that work are not derived from the Program, and can be reasonably considered independent and separate works in themselves, then this License, and its terms, do not apply to those sections when you distribute them as separate works. But when you distribute the same sections as part of a whole which is a work based on the Program, the distribution of the whole must be on the terms of this License, whose permissions for other licensees extend to the entire whole, and thus to each and every part regardless of who wrote it. Thus, it is not the intent of this section to claim rights or contest your rights to work written entirely by you; rather, the intent is to exercise the right to control the distribution of derivative or collective works based on the Program. In addition, mere aggregation of another work not based on the Program with the Program (or with a work based on the Program) on a volume of a storage or distribution medium does not bring the other work under the scope of this License.
4. You may copy and distribute the Program (or a work based on it, under Section 2) in object code or executable form under the terms of Sections 1 and 2 above provided that you also do one of the following:
 - a. Accompany it with the complete corresponding machine-readable source code, which must be distributed under the terms of Sections 1 and 2 above on a medium customarily used for software interchange; or,
 - b. Accompany it with a written offer, valid for at least three years, to give any third party, for a charge no more than your cost of physically performing source distribution, a complete machine-readable copy of the corresponding source code, to be distributed under the terms of Sections 1 and 2 above on a medium customarily used for software interchange; or,

- c. Accompany it with the information you received as to the offer to distribute corresponding source code. (This alternative is allowed only for noncommercial distribution and only if you received the program in object code or executable form with such an offer, in accord with Subsection b above.) The source code for a work means the preferred form of the work for making modifications to it. For an executable work, complete source code means all the source code for all modules it contains, plus any associated interface definition files, plus the scripts used to control compilation and installation of the executable. However, as a special exception, the source code distributed need not include anything that is normally distributed (in either source or binary form) with the major components (compiler, kernel, and so on) of the operating system on which the executable runs, unless that component itself accompanies the executable. If distribution of executable or object code is made by offering access to copy from a designated place, then offering equivalent access to copy the source code from the same place counts as distribution of the source code, even though third parties are not compelled to copy the source along with the object code.
5. You may not copy, modify, sublicense, or distribute the Program except as expressly provided under this License. Any attempt otherwise to copy, modify, sublicense or distribute the Program is void, and will automatically terminate your rights under this License. However, parties who have received copies, or rights, from you under this License will not have their licenses terminated so long as such parties remain in full compliance.
6. You are not required to accept this License, since you have not signed it. However, nothing else grants you permission to modify or distribute the Program or its derivative works. These actions are prohibited by law if you do not accept this License. Therefore, by modifying or distributing the Program (or any work based on the Program), you indicate your acceptance of this License to do so, and all its terms and conditions for copying, distributing or modifying the Program or works based on it.
7. Each time you redistribute the Program (or any work based on the Program), the recipient automatically receives a license from the original licensor to copy, distribute or modify the Program subject to these terms and conditions. You may not impose any further restrictions on the recipients' exercise of the rights granted herein. You are not responsible for enforcing compliance by third parties to this License.
8. If, as a consequence of a court judgment or allegation of patent infringement or for any other reason (not limited to patent issues), conditions are imposed on you (whether by court order, agreement or otherwise) that contradict the conditions of this License, they do not excuse you from the conditions of this License. If you cannot distribute so as to satisfy simultaneously your obligations under this License and any other pertinent obligations, then as a consequence you may not distribute the Program at all. For example, if a patent license would not permit royalty-free redistribution of the Program by all those who receive copies directly or indirectly through you, then the only way you could satisfy both it and this License would be to refrain entirely from distribution of the Program. If any portion of this section is held invalid or unenforceable under any particular circumstance, the balance of the section is intended to apply and the section as a whole is intended to apply in other circumstances. It is not the purpose of this section to induce you to infringe any patents or other property right claims or to contest validity of any such claims; this section has the sole purpose of protecting the integrity of the free software distribution system, which is implemented by public license practices. Many people have made generous contributions to the wide range of software distributed through that system in reliance on consistent application of that system; it is up to the author/donor to decide if he or she is willing to distribute software through any other system and a licensee cannot impose that choice. This section is intended to make thoroughly clear what is believed to be a consequence of the rest of this License.
9. If the distribution and/or use of the Program is restricted in certain countries either by patents or by copyrighted interfaces, the original copyright holder who places the Program under this License may add an explicit geographical distribution limitation excluding those countries, so that distribution is permitted only in or among countries not thus excluded. In such case, this License incorporates the limitation as if written in the body of this License.
10. The Free Software Foundation may publish revised and/or new versions of the General Public License from time to time. Such new versions will be similar in spirit to the present version, but may differ in detail to address new problems or concerns. Each version is given a distinguishing version number. If the Program specifies a version number of this License which applies to it and "any later version", you have the option of following the terms and conditions either of that version or of any later version published by the Free Software Foundation. If the Program does not specify a version number of this License, you may choose any version ever published by the Free Software Foundation.

11. If you wish to incorporate parts of the Program into other free programs whose distribution conditions are different, write to the author to ask for permission. For software which is copyrighted by the Free Software Foundation, write to the Free Software Foundation; we sometimes make exceptions for this. Our decision will be guided by the two goals of preserving the free status of all derivatives of our free software and of promoting the sharing and reuse of software generally.

NO WARRANTY

12. Because the program is licensed free of charge, there is no warranty for the program, to the extent permitted by applicable law. Except when otherwise stated in writing the copyright holders and/or other parties provide the program "as is" without warranty of any kind, either expressed or implied, including, but not limited to, the implied warranties of merchantability and fitness for a particular purpose. The entire risk as to the quality and performance of the program is with you. Should the program prove defective, you assume the cost of all necessary servicing, repair or correction.
13. In no event unless required by applicable law or agreed to in writing will any copyright holder, or any other party who may modify and/or redistribute the program as permitted above, be liable to you for damages, including any general, special, incidental or consequential damages arising out of the use or inability to use the program (including but not limited to loss of data or data being rendered inaccurate or losses sustained by you or third parties or a failure of the program to operate with any other programs), even if such holder or other party has been advised of the possibility of such damages.

End of terms and conditions