

Historique III™

Chapel™ Series

Copyright © 2013 Allen Organ Company
All Rights Reserved

ALLEN ORGAN COMPANY

For more than sixty years--practically the entire history of electronic organs-- Allen Organ Company has built the finest organs that technology would allow.

In 1939, Allen built and marketed the world's first electronic oscillator organ. The tone generators for this instrument used two hundred forty-four vacuum tubes, contained about five thousand components, and weighed nearly three hundred pounds. Even with all this equipment, the specification included relatively few stops.

By 1959, Allen had replaced vacuum tubes in oscillator organs with transistors. Thousands of transistorized instruments were built, including some of the largest, most sophisticated oscillator organs ever designed.

Only a radical technological breakthrough could improve upon the performance of Allen's oscillator organs. Such a breakthrough came in conjunction with the United States Space Program in the form of highly advanced digital microcircuits. In 1971, Allen produced and sold the world's first musical instrument utilizing digitally sampled voices!

Your organ is significantly advanced since the first generation Allen digital instrument. Organs with Renaissance™ technology are the product of years of advancements in digital sound and control techniques by Allen Organ Company. This system represents the apex of digital technology applied to exacting musical tasks. The result is a musical instrument of remarkably advanced tone quality and performance.

Congratulations on the purchase of your new Allen Organ! You have acquired the most advanced electronic organ ever built, one that harnesses a sophisticated custom computer system to create and control beautiful organ sound. Familiarize yourself with the instrument by reading through this booklet.

Contents

I.	ORGAN STOPS.....	1
II.	SPECIALIZED STOP CONTROLS.....	2
III.	EXPRESSION SHOE (Volume Control Pedal).....	3
IV.	SETTING CAPTURE REGISTRATIONS.....	3
V.	ARTISTIC REGISTRATION.....	3
VI.	TRANSPOSER.....	6
VII.	ACOUSTIC PORTRAIT™.....	7
VIII.	INSTALLATION, VOICING, AND CARE OF THE ORGAN.....	7
IX.	SAFETY INFORMATION.....	9
X.	CONSOLE CONTROLLER™ GUIDE.....	11

I. ORGAN STOPS

PITCH FOOTAGE

The number appearing on each stop, along with its name, indicates the “pitch” or “register” of the particular stop. Organs can produce notes of different pitches from a single playing key. When this sound corresponds to the actual pitch of the played key, the stop is referred to as being of 8’ (eight foot) pitch; therefore, when an 8’ stop is selected and Middle C is depressed, the pitch heard is Middle C. If the sounds are an octave higher, it is called 4’ or octave pitch. If two octaves higher, it is called 2’ pitch. A stop sounding three octaves higher is at a 1’ pitch. Similarly, a 16’ stop sounds an octave lower and a 32’ stop two octaves lower.

Stops of 16’, 8’, 4’, 2’ and 1’ pitch all have octave relationships, that is, these whole numbered stops all sound at octaves of whatever key is depressed. Non-octave pitches are also used in organs. Their footage numbers contain a fraction and they are referred to as *Mutations*. Among these are the 2-2/3’ *Nasard*, 1-3/5’ *Tierce*, 1-1/3’ *Quintflöte* and 2-2/3’ *Twelfth*. Because they introduce unusual pitch relationships with respect to the 8’ tone, they are most effective when combined with other stops and used either in solo passages or in small ensembles of flutes.

TONAL FAMILIES

1. Flues

Organ tones divide into two main categories: *flues* and *reeds*. In pipe organs, flue pipes are those in which the sound is set in motion by wind striking directly on the edge of the mouth of the pipe. Flues include principal, flute and string tones. Compound stops and hybrid stops are variations within these three stop families.

The term “imitative” means that the organ stop imitates the sound of a corresponding orchestral instrument; for example, an imitative 8’ Viola stop sounds like an orchestral viola.

<u>Principal Voices</u> Principal, Diapason, Octave, Fifteenth, Quinte	Characteristic organ tones, not imitative of any orchestral instruments. Usually present at many pitches and in all divisions. Rich, warm and harmonically well developed.
<u>Flute Voices - Open:</u> Harmonic Flute, Koppleflöte, flute mutation stops <u>Flute Voices - Stopped:</u> Holzgedackt, Bourdon, Lieblichgedackt, Rohr Bourdon	Lesser harmonic development than Principals. Open flutes are somewhat imitative; stopped flutes are not. Present at all pitch levels and in all divisions.
<u>String Voices</u> Gamba, Salicional, Viole Céleste	Mildly imitative and brighter harmonic development than Principals. Usually appear at 8’ first; can be 4’ & 16’ ranks.
<u>Compound Voices</u> Mixture, Fourniture	Voices produced by more than one rank sounding simultaneously. Best registered with other stops.
<u>Hybrid Voices</u> Erzähler, Spitzflöte	Voices that combine the tonal characteristic of two families of sound, e.g., flutes and principals, or strings and principals.

2. Reeds

In *reed* pipes, a metal tongue vibrates against an open flattened side of a metal tube called a shallot. The characteristic sounds of different reeds are produced through resonators of different shapes. The family of reeds subdivides as follows:

<p><u>Chorus or Ensemble:</u></p> <p>Double Trumpet, Tromba, Posaune, Clarion, Bombarde</p> <p><u>Solo:</u></p> <p>Hautbois, Clarinet, Krummhorn</p>	<p>Voices of great harmonic development; some are imitative of their orchestral counterparts.</p>
--	---

Your Allen Organ provides authentic, digitally sampled voices. They are protected by copyrights owned by the Allen Organ Company and are stored in memory devices, each having affixed to it a copyright notice; e.g., © 2003 AOCO, © 2001 AOCO, etc., pursuant to Title 17 of the United States Code, Section 101 et seq.

II. SPECIALIZED STOP CONTROLS

Some organ stop controls do not turn voices on/off, but instead turn on/off console functions such as outlined in this Section.

Great to Pedal	Connects all Great stops to the Pedal.
Swell to Pedal	Connects all Swell stops to the Pedal.
Positiv to Pedal	Connects all Positiv stops to the Pedal.
Positiv to Great	Connects all Positiv stops to the Great.
Swell to Positiv	Connects all Swell stops to the Positiv.
Swell to Great	Intermanual coupler connecting all Swell stops to the Great manual.
MIDI on Pedal	Opens MIDI channel to the Pedal.
MIDI on Swell	Opens MIDI channel to the Swell
MIDI on Great	Opens MIDI channel to the Great.
MIDI on Positiv	Opens MIDI channel to the Positiv.
Tremulant	This stop provides a vibrato effect, natural in the human voice and wind instruments.
Gt-Pd Unenclosed	The expression control for the Great and Pedal Divisions is disabled, causing the Great and Pedal stops to sound at full volume, regardless of the position of the expression shoe.
Bass Coupler	When playing on the Great manual, the lowest key played on the Great will automatically play stops drawn on the Pedal division, in addition to those stops drawn on the Great. This allows voices normally played from the pedalboard to be heard without using the pedalboard.
Alternate Tuning	When activated, the organ's tuning will change to an alternate tuning selected within the Console Controller™. See the Console Controller Guide, later in this Manual, for more information relating to Alternate Tunings.

III. EXPRESSION SHOE (Volume Control Pedal)

The organ's expression pedal (called a "shoe") is used to control the organ's volume (expression).

IV. SETTING CAPTURE REGISTRATIONS

SETTING GENERAL PISTONS

Your Allen organ's capture system lets you set stop registration combinations in each of its available capture memories. The Historique III™ has a set of twelve (12) General pistons centrally located under the Swell and Great manuals.

- ❑ First, select the stops you wish to save.
- ❑ Press and hold the **SET** Piston.
- ❑ Press and release the desired GENERAL piston.
- ❑ Finally, release the **SET** Piston.

Remember, General pistons are customarily set from soft to loud using graduated stop combinations. The pistons you have set "remember" the registration combinations that you have assigned to each of them. Each time a General piston is pressed, the registration assigned to it is activated. You can change stop registration combinations at any time by repeating the above procedure.

V. ARTISTIC REGISTRATION

(Trained organists might not need to review this section.)

Organ registrations fall into two broad categories; *solo combinations* and *ensembles*. A solo combination is one in which a melody is played on one keyboard, the accompaniment on another keyboard. The pedal often provides a light bass line. Almost any stop or combination of stops will sound good as a solo voice. A contrasting tone quality should be chosen for the accompaniment, so that the accompaniment is softer than the solo voice. The Pedal stops must provide a foundation for the solo and accompaniment without covering them.

Most 8' reed stops make interesting solo voices. The addition of a 4' flute or a flute mutation (e.g., Nasard or Tierce) to a reed such as the Trompette colors the sound further and increases its volume slightly. Adding an 8' flute to a reed adds body to the sound.

Flutes can be used alone or in combinations as solo voices. One special combination of flutes that creates an appealing and historically significant solo combination is the Cornet (pronounced kor-NAY). The Cornet is created by using the following Swell stops: Gedackt 8', Koppelflöte 4', Nasard 2-2/3', Blockflöte 2' and Tierce 1-3/5'. This solo combination, widely used for Baroque organ music, is just as appropriate for some modern music. Useful variations of the Cornet may be achieved by eliminating the 4', the 2', or even both.

When choosing stops for a solo voice, it is not always necessary to include an 8' stop; for example, since the 4' flute has a tone quality different from that of the 8' flute, the 4' flute can be used as an independent solo voice. By playing a solo voice an octave lower than written, the notes sound at the correct pitch. In similar fashion, a 16' stop can be selected and the notes played an octave higher than written. Tonal variety is gained, because each stop has its own tone color.

For accompaniment, the most desirable voices are the 8' flutes or strings on each manual. Celestes often make effective accompaniments. The correct choice depends on the volume of the solo tone (a soft solo voice requires the softest accompaniment stop), the element of contrast, and the location of the solo stop. A bright, harmonically rich solo reed, for example, can be accompanied by either a string or flute, though the flute often contributes greater interest because of its greater contrast. Try to seek a "natural" balance of volume between solo and accompaniment.

SUGGESTED SOLO REGISTRATIONS

SWELL SOLO COMBINATION

Swell: Gedackt 8', Koppelflöte 4', Nasard 2-2/3', Blockflöte 2', Tierce 1-3/5'

Great: Harmonic Flute 8', Spitzflöte 4'

Pedal: Lieblich gedackt 16', Gedacktflöte 8'

[Play solo on Swell]

FLUTE SOLO COMBINATION

Swell: Salicional 8', Voix Celeste 8'

Great: Harmonic Flute 8'

Pedal: Lieblich gedackt 16', Swell to Pedal

[Play solo on Great]

TRUMPET SOLO COMBINATION

Swell: Trompette 8'

Great: Principal 8', Octave 4', Super Octave 2', Mixture IV

Pedal: Bourdon 16', Octave 8', Choral Bass 4'

[Play solo on Swell]

These few combinations demonstrate basic techniques of solo registration. In creating registrations of your own, remember these three simple rules:

- Seek tonal contrast between solo and accompaniment.
- Be sure the solo is louder than the accompaniment.
- Choose a solo whose character is appropriate to the specific piece.

ENSEMBLE REGISTRATIONS

Volumes have been written on the subject of ensemble registration. Following is a summary of the major points.

- Ensemble registrations involve groups of stops that are played together, usually, but not always, with both hands on one keyboard. They are characterized by compatibility of tone, clarity, and occasionally power. Such registrations are used in hymn singing, choir accompaniments, and much of the contrapuntal organ literature.
- Two factors are always to be considered: tone quality and pitch. Ensembles begin with a few stops at the 8' and/or 4' pitch and expand "outward" in pitch as they build up. New pitches are usually added in preference to another 8' stop.

Ensembles are generally divided into three tonal groupings called “choruses”:

The Principal Chorus is the most fully developed with representation in various divisions of the organ and at every pitch from 16’ to high mixtures. The Principal Chorus is sometimes called the narrow-scale flue chorus, a reference to the relative thinness of Principal pipes in relation to their length.

The Flute Chorus is also well represented with a diversity of stops at various pitches. Generally speaking, the Flute Chorus is composed of less harmonically developed tones, and is smoother and of lesser volume than the Principal Chorus. The Flute Chorus is sometimes called the wide-scale flue chorus, owing to the generally “fatter” look of Flute pipes as compared to Principals.

The Reed Chorus includes those reed tones designed to be used in the ensemble buildup. Not all reed voices are ensemble tones. A Clarinet, for example, is usually a solo stop. The various Trumpets, Clairons, Bassons, etc., are usually ensemble voices that add brilliance, power, and incisiveness to the sound. If you have questions as to whether a specific reed is a solo or ensemble stop, refer to the stop list in the preceding section.

The Swell Reed Chorus is a special ensemble of Basson 16’ and Trompette 8’. It represents an entity important to French organ music and the full ensemble of the organ. These stops create a “blaze” of richly harmonic sounds that tops off both flue choruses.

Another special ensemble combination important in French music is the **Cornet** (described in the section on Solo Registration). This combination can be used with the chorus reeds and mutations to create the “Grand Jeu.” The Cornet is also useful in Romantic ensembles, adding weight and thickness to the sound.

SUGGESTED ENSEMBLE COMBINATION REGISTRATIONS:

GREAT ENSEMBLE COMBINATIONS

1. Harmonic Flute 8’, Spitzflöte 4’
2. Harmonic Flute 8’, Spitzflöte 4’, Super Octave 2’
3. Principal 8’, Octave 4’
4. Principal 8’, Octave 4’, Super Octave 2’
5. Principal 8’, Octave 4’, Super Octave 2’, Mixture IV
6. Principal 8’, Harmonic Flute 8’, Octave 4’, Spitzflöte 4’, Super Octave 2’, Mixture IV

SWELL ENSEMBLE COMBINATIONS

1. Gedackt 8’, Salicional 8’
2. Gedackt 8’, Salicional 8’ Koppelflöte 4’
3. Gedackt 8’, Salicional 8’ Koppelflöte 4’, Super Octave 2’
4. Gedackt 8’, Salicional 8’ Koppelflöte 4’, Super Octave 2’
5. Gedackt 8’, Salicional 8’ Koppelflöte 4’, Super Octave 2’, Mixture IV
6. Gedackt 8’, Salicional 8’ Koppelflöte 4’, Super Octave 2’, Mixture IV, Trompette 8’

The use of the Swell to Great coupler allows these separate ensembles to be combined on the Great manual. It is also possible to combine some of these ensembles within the same division; for example, when the #5 Great and #3 Swell registrations are coupled together and played on the Great, they combine to form a nice round hymn combination.

The Pedal ensemble is created in much the same way as the manual ensembles, starting at 16’ pitch instead of 8’. Be careful that the volume of the pedals is not greater than that of the manuals. Although the manual to pedal couplers are useful in bringing clarity to the pedal line, especially on softer registrations, avoid the temptation to rely constantly on one or two 16’ stops

and a coupler. Please note that the softest stops and flute mutations are normally not used with ensembles.

FULL ORGAN

Due to the immense capabilities of the organ, every stop and coupler on the instrument could be used simultaneously without distortion, if the organ is adjusted properly. In good registration practice, however, the organist would not haphazardly put on every stop on the instrument. For best results, listen and include only those stops that really contribute to the fullness and brilliance of the ensemble. Eliminate soft stops and solo stops that make no purposeful contribution.

This short treatment barely scratches the surface of the fascinating subject of organ registration. For those interested in gaining further insight into this vital area of organ playing, we recommend the following texts:

Audsley, George Ashdown. *Organ Stops and their Artistic Registration*.

Hialeah, FL: C.P.P. Belwin, 1985.

Irwin, Stevens. *Dictionary of Pipe Organ Stops*. 2nd ed.

New York: Macmillan Books, 1983.

VI. TRANSPOSER

Vast computer capability makes it possible to perform the sometimes difficult task of transposing, while allowing the organist to play in the notated key. The Console Controller™ controls the operation of the Transposer. The Console Controller™ is located at the left side of the console.

Transposition to any of the twelve musical keys is possible. When the organ's power is first turned ON, the Console Controller™ window displays a brief message then displays MEM - 1, indicating the first capture memory. Also displayed is the Transposer setting of neutral pitch. The Transposer is displayed as a large digit in the Console Controller display. (“ ” is on the right side of the display.) When the organ's power is first switched ON, the organ will start up in Memory 1 and in this neutral pitch position.

To shift the music to a higher key, you must first move the cursor's position in the Console Controller's™ display window so that the “ ” symbol is selected. To move the cursor, repeatedly press the button on the Console Controller™ labeled "CURSOR" until the “ ” symbol is selected. Once the “ ” symbol is selected, turn the Console Controller's Rotary Dial to select the new musical key. Turning the dial in a clockwise manner selects higher keys and causes the organ's pitch to rise. Turning the dial in a counter-clockwise manner selects a lower key and causes the organ's pitch to go lower. The pitch can be raised a maximum of five half-steps or lowered a total of seven half-steps. Be aware that the Transposer's range settings "wrap around" from the plus five half-step setting to the minus seven half-step setting.

A red indicator light (LED) on the face of the Console Controller™ illuminates any time the Transposer setting is moved from the “ ” or neutral pitch position.

Why Transpose?

- Because a song's range does not always suit the vocal range of a particular singer. By adjusting the Transposer, the piece can be sung more comfortably and effectively.
- Because some instruments are non-concert pitch. A trumpet in B^b, for example, can play the same music as the organist, if the Transposer knob is set two half steps lower.
- Because hymn singing can sometimes be improved by a more favorable key selection.

VII. ACOUSTIC PORTRAIT™

Allen Organs are the only digital organs to bring the science of sampling to acoustics! Ordinary electronic reverb is a synthetic imitation of acoustics “applied to” the sound, not created as an integral part of it. Acoustic Portrait™ produces the real thing in exacting detail!

Acoustic Portrait™ begins with a sampling process using impulse responses that measure an actual room’s acoustic properties. These measurements are then stored in the organ's computer memory. Through an advanced real-time mathematical process called “convolution”, the acoustics of the sampled room actually become an integral part of the organ’s sound, producing a noticeably smoother, more natural result than synthetic reverb. Allen engineers have recorded the acoustics of cathedrals and other acoustically desirable buildings throughout the world. With advanced processors (DSP) and patented low-latency convolution algorithms, Acoustic Portrait™ reproduces the true acoustic response of each original room with stunning realism! Each organ equipped with Acoustic Portrait™ features 10 different Acoustic Portraits, ranging from intimate rooms to cavernous cathedrals.

The switch labeled ACOUSTIC PORTRAIT in the Console Controller™ must be ON to hear the selected Acoustic Portrait. The selected Acoustic Portrait™ gain, measured in dB (decibels), can be accessed and adjusted in the Console Controller™. See the Console Controller™ guide later in this manual for more detailed instructions on Acoustic Portrait™ settings and adjustments.

When changing to a different Acoustic Portrait™, the new selection will automatically load in (approx.) 3 seconds.

VIII. INSTALLATION, VOICING, AND CARE OF THE ORGAN

INSTALLATION

Wherever your organ may be situated, careful installation is a prerequisite to successful results. Your Allen representative is well qualified to guide you in planning the finest possible installation. Factory assistance in planning the installation is also available and may, in fact, be sought by your Allen Organ representative.

VOICING

Your organ presents unprecedented accuracy in the scaling and voicing of each note of every stop. Repertoire™ has a software package¹ available which allows the organist to adjust the many intricate tonal features of the organ such as note by note and rank by rank volume levels as well as access to the more common controls bass and treble controls of the individual audio channels. QDOVE™ is the name of Allen Organ’s proprietary voicing software which allows access to these exclusive features as well as many others which gives the user complete and *tonal* control. Contact your local Allen Organ representative for more details on this exciting software package!

CARE OF THE ORGAN

Your Allen Organ constitutes a major advance in long-term maintenance-free operation. There is no regular maintenance procedures required and, therefore, no periodic maintenance schedules to be observed.

Reasonable care will keep the instrument looking beautiful for years to come. The wood surfaces may be cleaned using a soft cloth dampened with lukewarm water. A mild solution of lukewarm water and dish detergent may be used to remove fingerprints, etc. Polish dry with a soft cloth. Do not use wax, sprays or oils on the finish. Satin finished surfaces will take on a semi-gloss appearance when waxed and will eventually become yellowed.

Keys and stop tablets should be cleaned in the following manner: Use two clean cloths. Immerse one in clear, lukewarm water and wring it thoroughly damp dry. Loosen the dirt with this cloth, and then polish immediately with the dry cloth. Do not use soap or detergent on keys or stop tablets.

To polish the clear music rack, a furniture wax polish may be sprayed on a soft dry cloth and rubbed on the front of the music rack. Keep the wax off of the wood finishes. This will help keep the music rack clear.

You have purchased a remarkable organ that not only faithfully reproduces the organ traditions of the past but also anticipates the innovations of the future. Should you have questions that are not addressed in this manual, please do not hesitate to contact your local Allen Organ representative. Welcome to the family of satisfied Allen Organ owners!

IX. SAFETY INFORMATION

USA ONLY

CAUTION

Never plug the instrument into any current source other than 110 to 120 volts, 50/60 Hertz alternating current (AC). A verified grounded outlet is essential to proper operation and protection of the instrument. Proper polarity should be checked with an AC circuit analyzer before connecting the organ.

Do not change the cable plug or remove the ground pin or connect with a two-pole ground lift adapter.

If you are in doubt about your electrical connection, consult your local electrician or power company.

In facilities where circuit breakers are turned off between uses (as for example, between worship services), the circuit breaker affecting the organ console AC power should have a guard installed to prevent it from accidentally being switched off.

It is important that you read and comply with all instructions and labels that might be attached to the instrument.

INTERNATIONAL ONLY

CAUTION

Do not plug the instrument into any current source other than that stated by the selling dealer. Proper polarity should be checked with an AC circuit analyzer before connecting the organ.

Do not change the cable plug or remove the ground pin (if applicable).

If you are in doubt about your electrical connection, consult your local electrician or power company.

In facilities where circuit breakers are turned off between uses (as for example, between worship services), the circuit breaker affecting the organ console AC power should have a guard installed to prevent its being accidentally switched off.

Read and comply with all instructions and labels that may be attached to the instrument.

Warning: This equipment generates, uses, and can radiate radio frequency energy and, if not installed and used in accordance with the instruction manual, may cause interference to radio communications. It has been type tested and found to comply with the limits for a Class B Computing Device in accordance with the specifications in Subpart J of Part 15 of FCC Rules, which are designed to provide reasonable protection against such interference in a residential installation. Should this equipment cause interference to radio communications, the user at his own expense will be required to take whatever measures may be necessary to correct the interference. Whether this equipment actually causes the interference to radio communications can be determined by turning the equipment off and on. The user is encouraged to attempt to correct the interference by one or more of the following measures:

Reorient the receiving antenna.

Relocate the organ with respect to the receiver.

Move the organ away from the receiver.

Plug the organ into a different electrical outlet, so that the organ and receiver are on different branch circuits.

If necessary, the user should consult the dealer or an experienced radio technician for additional suggestions.

CE mark shows compliance with the EMC Directive.

X. CONSOLE CONTROLLER™ GUIDE

A.	BASIC OPERATION	12
1.	Start-Up Sequence.....	12
2.	Advancing Through the Windows.....	13
3.	Selecting the Capture Memories.....	13
4.	Saving Registrations Using The Pistons.....	13
5.	Locking Capture Memories	14
6.	Unlocking Memories Using Your Code.....	14
7.	Unlocking All Memories If You Forget Your Code	15
8.	Stop Action and Capture Self Check	15
9.	Stoplist Library™ (<i>optional</i>).....	16
10.	Acoustic Portrait™ Settings	16
B.	ADVANCED OPERATION	18
1.	Selecting an Alternate Tuning	18
2.	Configuring General Pistons.....	18
3.	Restoring Original Factory Settings	20
4.	Global Tuning	20
5.	Headphone Volume.....	21
C.	MIDI FUNCTIONS	22
1.	Standard MIDI Channel Assignments	22
2.	Selecting Program Change Modes, Viewing Program Numbers or General MIDI Sound Names	22
3.	General MIDI Sound Names or Program Numbers	23
4.	Assigning MIDI Program Changes to Organ Pistons.....	25
5.	MIDI Bank Selecting	25
6.	Changing the MIDI Base Channel.....	27
7.	MIDI Expression Settings.....	27
8.	MIDI Sustain Kick Switch (<i>optional</i>).....	28
9.	Organ Local Off	28
10.	Transferring and Saving Capture Memory Data to a Sequencer	29
11.	Return Capture Memory Data from a Sequencer to the Organ.....	29
12.	Transmission/Reception of Individual Stop Data.....	30
D.	QUICK REFERENCE GUIDE	31
1.	Basic Operations Review	31
2.	Advanced Operations Review	31
E.	MIDI GUIDE.....	32
1.	MIDI for Organists.....	32
2.	Allen's Exclusive MIDI System.....	33
3.	MIDI Transmission Channels	34
4.	GENERAL MIDI SOUND SET.....	35

INTRODUCTION

The Console Controller™ is an interface that controls many organ functions and a variety of MIDI functions. The Console Controller includes a LCD (liquid crystal display) window that displays functions, one at a time, as well as an integrated Rotary Dial with push buttons used to make selections. Each window function is described in detail.

A. BASIC OPERATION

1. Start-Up Sequence

Turn on the organ's main power switch. The LCD window will display, in sequence:

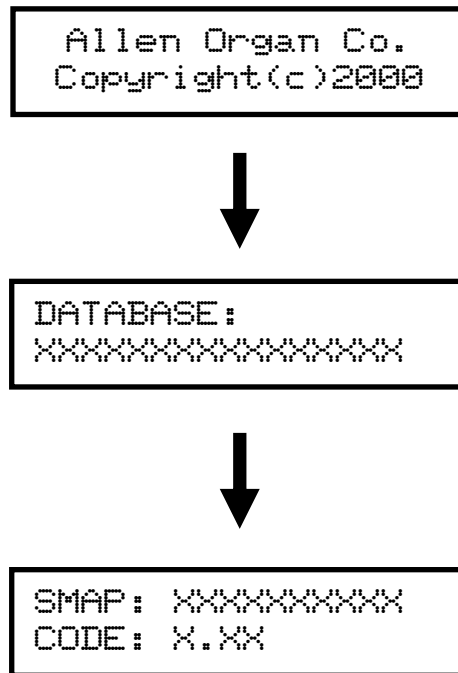

Note: The LCD will display the current stopmap level (SMAP) and operating software base code level (CODE) currently installed in the organ.

Then finally the *Main Window* function is displayed:

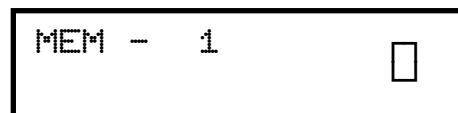

Important: The Allen Organ includes several self-testing features. If a warning is displayed within this sequence, you should contact your Allen authorized representative immediately!

2. Advancing Through the Windows

The Allen Organ operating software contains many settings that are user-programmable. Each programmable setting can be adjusted via the Console Controller™. These programmable settings are divided up into many window functions. To advance the Console Controller's™ display to the next window function, locate and press the **CURSOR** button until the blinking **CURSOR** is positioned over the abbreviation “**MEM**” in the display. Once the cursor is positioned, slowly turn the **ROTARY DIAL** clockwise, the display will advance to the next window function. When the second window function is displayed, rotate the **ROTARY DIAL** counter-clockwise, the window will return to the Main window display function. Turn the **ROTARY DIAL** counter-clockwise again and the last window function will display. The window functions “wrap around” for ease of accessing functions quickly.

Remember: You may return to the *Main Window* function at any time by pressing and holding the **SET** piston. Then, while holding **SET**, press the **CANCEL** piston, release both pistons. This procedure will always return the Console Controller's display to the Main Window function.

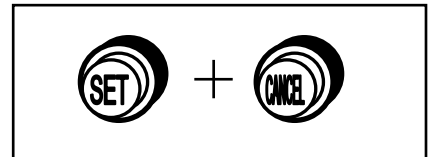

For reference, the last window function is:



3. Selecting the Capture Memories

Locate the **CURSOR** button on the Console Controller™. Press this button to move the cursor to the first number to the right of the abbreviation “**MEM**” on the display. Once the cursor is positioned on the memory number, turn the **ROTARY DIAL** clockwise to select the memories sequentially from **MEM 1, to MEM 2, to MEM 3**. Or, turn the **ROTARY DIAL** counter-clockwise to select the memories sequentially from **MEM 1, to MEM 8, to MEM 7**.

The capture memories allow you to save different registrations on each piston/toe piston. This means **General Piston 1** on **MEM-1** may be totally different from **General Piston 1** on **MEM-2, MEM-3, etc**.

4. Saving Registrations Using The Pistons

A **registration** is any combination of stops. These registrations can be stored (remembered) by the organ's capture memory system. The pistons provide a way to make changes quickly from one registration to another.

Historique III™ is equipped with twelve (12) General pistons. General pistons are those that affect all stops on the organ. They are centrally located under the front of the Swell and Great keyboard on the piston rails.

To Save a Registration to a General Piston:

The *Main Window* function in the Console Controller™ must be displayed (*See Section A-2*). Select any memory number (MEM-1, MEM-2 ... MEM-4, etc.) (*see section A-3*); however, for this example use MEM-1. Next, select the desired stops you want General Piston 1 to remember. Once the selected stops are lit, press and hold the **SET** piston, then press and release General Piston 1. Finally, release the **SET** piston. General Piston 1 will now store in memory the selected stops you selected.

Note: *General Pistons are often set gradually from soft to loud with General 1 the softest and General 12 the loudest.*

5. Locking Capture Memories

All memories, except Memory 1, may be locked or unlocked individually to prevent unintentional or unauthorized changes to that memory's contents. Memory 1 remains unlocked as a convenience to visiting or substitute organists (if applicable). The Console Controller must display the *Main Window* function (*See Section A-2*). Select a capture memory to lock. After registrations are stored to pistons, (*See Section A-4*) choose three digits you can easily remember (e.g., 1-2-3, 2-1-5, etc.). General Piston numbers reflect their respective digits listed on the piston. On the Console Controller™ locate the **MEMORY** button. Press and hold the **MEMORY** button. Then, while holding **MEMORY**, press the General Pistons that will correspond to your three-digit code. Release the **MEMORY** button and an "L" will appear next to the MEM number in the display, indicating this memory is now locked.

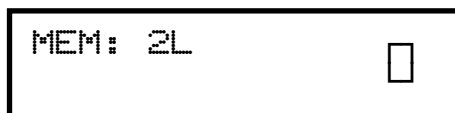

As long as the memory remains locked, the piston registrations on that memory cannot be changed. Other organists will still be able to use the locked registrations; however they cannot be changed. Remember; choose an easy to remember three-digit code.

Note: Each capture memory level lock code can be different!

6. Unlocking Memories Using Your Code

The *Main Window* function must be displayed (*See Section A-2*). To unlock a memory, select the capture memory to be unlocked. Remember, locked capture memories will have an "L" behind the number. Once a desired capture memory is selected, press and hold the **MEMORY** button in the Console Controller™. Then, while pressing **MEMORY**, enter the same three-digit code that was used to lock this memory (*See Section A-5*), using General Pistons 1 through 5. Release the **MEMORY** button. If the correct code was entered, the "L" will disappear, indicating that this memory is now unlocked.



7. Unlocking All Memories If You Forget Your Code

Advance to the 'UNLOCK ALL CAPTURE MEMORIES' window function (*see section A-2*).



Press and hold the **MEMORY** button on the Console Controller™, then press General Pistons 2-5-5, in sequence. Release the **MEMORY** button. The display will automatically return to the *Main Window* function. All capture memories are now unlocked, including those memories other organisms may have locked, however, registrations remain unchanged.

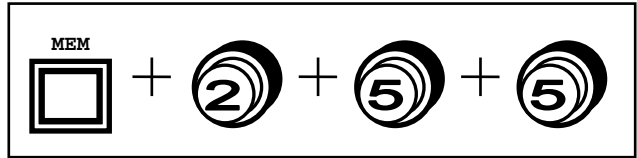

8. Stop Action and Capture Self Check

This feature self-checks the capture system. The test insures each stop is functioning properly and is controllable by the capture system. Advance to the 'SELF CHECK' window function (*see Section A-2*).



To start the self-check, press the **CURSOR** button on the Console Controller to position the flashing cursor on the word "OFF". Turn the **ROTARY DIAL** to start the Self Check function. The display will indicate that the Self Check function is now "ON". The stop indicators will turn on and off consecutively one at a time. *If any stop position does not light, notify your Allen service technician.* During the testing process you can interrupt and/or return to the *Main Window* function at any time by turning the **ROTARY DIAL** until "OFF" appears in the display or by using the **SET** and **CANCEL** pistons to return to the *Main Window* function (*see Section A-2*).

9. Stoplist Library™ (optional)

Historique III™ can be equipped to include nine complete voicing specifications. A new voicing specification can be selected from the Console Controller™ at any time. To change a voicing specification, advance to the 'STOPLIST LIBRARY™' window function (*see Section A-2*). The display will indicate the current voicing specification loaded.

```
STOPLIST LIBRARY
CLASSIC ALLEN
```

To change to a different voicing specification, press the **CURSOR** button on the Console Controller and position the cursor on the voicing specification name. Turn the **ROTARY DIAL** to select a different voicing specification. When the desired voicing specification is displayed, press and hold the **SET** piston. Then, while holding **SET**, press the **MEMORY** button on the Console Controller. Release both. The Console Controller will indicate the selected specification is loading. Once the new specification is loaded the capture system will automatically cancel all stops. The organ is now ready to play. To return to the *Main Window* function, press and hold the **SET** piston then press the **CANCEL** piston. Release both.

Important: The organ will not be able to be played while a new voicing specification is loading.

```
STOPLIST LIBRARY
SCHLICKER
```

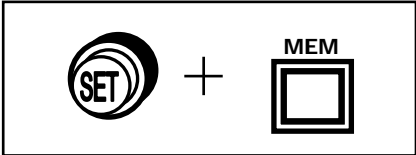

```
LOADING SUITE
SCHLICKER
```



```
STOPLIST LIBRARY
SCHLICKER
```

10. Acoustic Portrait™ Settings

There are 10 available Acoustic Portrait™ pallets to select from. The rocker switch labeled ACOUSTIC PORTRAIT™ in the Console Controller™ drawer must be ON to hear the Acoustic Portrait™ selection. The Acoustic Portrait™ gain (volume) can be adjusted. The gain is indicated in dB (decibels). The Acoustic Portrait™ gain range is adjustable from +6dB to minus 35dB. Minus 35dB is the least amount of gain while +6dB is the most available.

ACOUSTIC
PORTRAIT

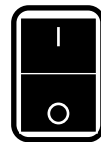

To change the active Acoustic Portrait™ or adjust the Acoustic Portrait™ gain, advance to the 'ACOUSTIC PORTRAIT™' window function (*see Section A-2*). The window will display the name of the currently selected Acoustic Portrait™ pallet on line 1 with the Gain setting on line 2.

```
Pipe Chamber
GAIN = -8dB
```

To change the Acoustic Portrait pallet, press the **CURSOR** button on the Console Controller until the cursor is positioned on the Acoustic Portrait pallet name. Turn the **ROTARY DIAL** on the Console Controller to select a different pallet name.

Note: The change will not be immediate. You must wait 3 seconds for the newly selected Acoustic Portrait pallet to load. The display will indicate that the newly selected pallet is loading:

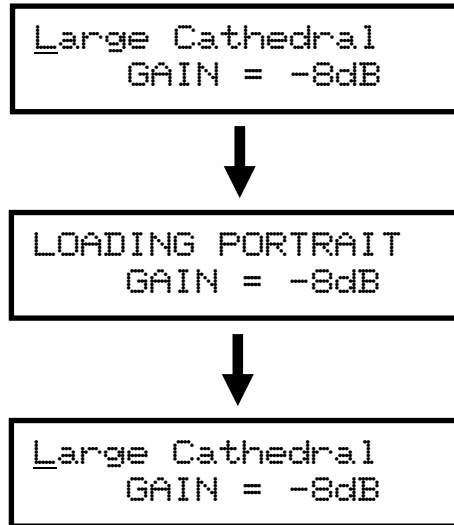

Acoustic Portrait Gain (Volume) Adjustment:

To change the Acoustic Portrait Gain setting, press the **CURSOR** button on the Console Controller until the cursor is positioned on the Acoustic Portrait gain setting. Turn the **ROTARY DIAL** on the Console Controller to change the gain setting. Gain adjustment range is from minus 35dB to +6db. Minus 35db is the least amount of gain while +6dB is the most or maximum amount of gain.

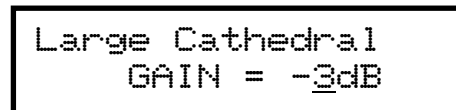
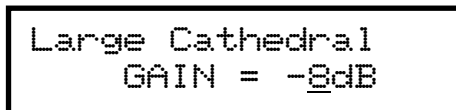

Acoustic Portrait™: Available Reverb Pallets

1. Pipe Chamber
2. Small Theatre
3. Small Church
4. Medium Room 1
5. Medium Room 2
6. Medium Room 3
7. Large Room 1
8. Large Room 2
9. Cathedral
10. Large Cathedral

B. ADVANCED OPERATION

1. Selecting an Alternate Tuning

Advance to the 'ALTERNATE TUNING' window function (*see section A-2*).



(The current Alternate Tuning will appear on line 2 of the display)

Allen Organs offer seven *Alternate Tunings*, plus one standard tuning. These tunings are accessible from the Console Controller™. To select an *Alternate Tuning*, press the **CURSOR** button on the Console Controller until the flashing cursor is positioned on the Alternate Tuning name (*line 2*). Turn the **ROTARY DIAL** to select one of the seven available tunings. The organ's overall tuning will be changed to the selected *Alternate Tuning*, by actuating the drawknob, or stop tablet engraved ALTERNATE TUNING.

The selected tuning will remain the *Alternate Tuning* until:

- Either another *Alternate Tuning* in the Console Controller is selected,
- Or, the stop/drawknob is turned off.

Any time the ALTERNATE TUNING stop is off, the organ is tuned to a standard general purpose tuning. **Note:** *The remaining tunings are of historical interest, but are limited in application to modern music. When selected, it is normal for some intervals to sound out of tune.*

2. Configuring General Pistons

This procedure enables pistons to control stops that are normally not controlled by those pistons.

Note: The Piston Configuration is common to all capture memories.

For example:

- (1) General Pistons can be configured to control only certain specific stops.
- (2) A General Piston can be configured so that it will only affect the Tremulant stops.
- (3) A General Piston can be configured to respond like a Divisional Piston.

Note 1: Changing the configuration of a piston *will not affect the registrations* previously remembered by that piston prior to its reconfiguration.

Note 2: Reconfiguring a piston does not change its MIDI channel assignment.

Configuring General Pistons to only affect MIDI stops:

Advance to the 'CONFIGURE PISTONS' window function (*see section A-2*).

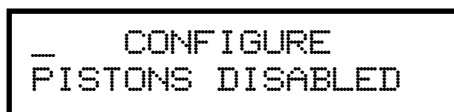

Press the **CURSOR** button until the cursor is positioned on “DISABLED” on the second line. Turn the **ROTARY DIAL** clock-wise until “ENABLED” appears on the display. This will activate Configure Piston mode.



A rectangular display box with a black border. The text inside is arranged in two lines: "CONFIGURE" on the top line and "PISTONS ENABLED" on the bottom line. The text is in a monospaced, all-caps font.

At this point, pressing any piston will illuminate stops which are controlled by that particular piston.

In this example, we will only program the MIDI stops. Select just the MIDI stops. Any stops not turned on, will not be able to be registered on that particular piston. Press and hold the **SET** piston. Then, while holding **SET**, press a General piston that you want only the MIDI stops to respond on. Release both. The General piston just pressed will now only be able to program the MIDI stops and will affect no other stops.

To return to the *Main Window* to store registrations to the pistons you just configured, press and hold the **SET** piston. Then, while holding **SET**, press **CANCEL**. Release both. (See Section A-4).

To reconfigure a General Piston so it controls only the Swell Division stops:

Advance to the ‘CONFIGURE PISTONS’ window function (see section A-2).



A rectangular display box with a black border. The text inside is arranged in two lines: "CONFIGURE" on the top line and "PISTONS DISABLED" on the bottom line. The text is in a monospaced, all-caps font.

Press the **CURSOR** button until the cursor is positioned on “DISABLED” on the second line. Turn the **ROTARY DIAL** clock-wise until “ENABLED” appears on the display. This will activate Configure Piston mode. At this point, pressing any piston will illuminate stops which are controlled by that particular piston.

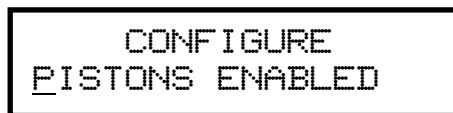

A rectangular display box with a black border. The text inside is arranged in two lines: "CONFIGURE" on the top line and "PISTONS ENABLED" on the bottom line. The text is in a monospaced, all-caps font.

Select *all* of the Swell division stops. Any stops not turned on, will not be able to be registered on that particular piston. Press and hold the **SET** piston. Then, while holding **SET**, press a General piston that you want only the Swell division stops to respond on. Release both. The General piston just pressed will now only be able to program the Swell division stops and will affect no other stops.

To return to the *Main Window* to store registrations to the pistons you just configured, press and hold the **SET** piston. Then, while holding **SET**, press **CANCEL**. Release both. (See Section A-4).

The use of the CONFIGURE PISTONS function is only limited by one’s creative imagination.

Remember: The above examples only determine which stops will become accessible by the reconfigured pistons; *they will not change previously saved registrations.*

3. Restoring Original Factory Settings

Advance to the 'RE-INITIALIZE' window function (*see Section A-2*). The window will display...



Certain functions can be restored to the original factory settings. They are:



The Piston Configuration re-initialization includes all the Configure Piston settings. The MIDI Settings re-initialization includes all MIDI program change mapping. The Capture Memory re-initialization will reset the last available capture memory to factory default registrations (*if applicable*).

Each of these functions can be restored individually. To select the factory settings you wish to restore press the **CURSOR** button until the cursor is positioned on the parameter value located on the 2nd line of the display. Press and hold the **MEMORY** button on the Console Controller. Then, while holding the **MEMORY** button, press General Pistons 2-5-5 in sequence. The display will briefly flash the word "WORKING" on the first line of the display to indicate that the current command function is being re-initialized.

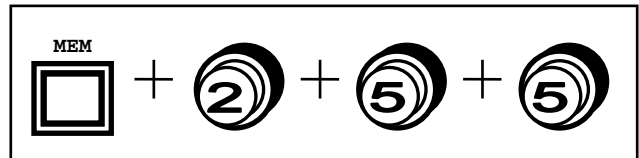

4. Global Tuning

Global Tuning allows the organist to adjust the pitch of the entire organ. This tuning adjustment allows the organ to be tuned to another instrument more easily. Tuning can be adjusted either ± 100 cents from A-440 pitch. To adjust Global Tuning, advance to the 'GLOBAL TUNING' window function (*see Section A-2*).

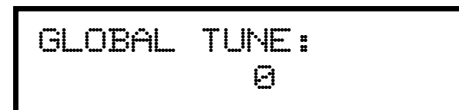

Press the **CURSOR** button until the flashing cursor is positioned on the current tuning value. Turn the **ROTARY DIAL** in either direction to raise or lower the pitch of the organ. The Global Tuning adjustment will be retained in memory when the organ is powered off.

5. Headphone Volume

The master headphone volume control is integrated into the Console Controller™. Adjusting this setting will change the overall output volume level of the headphone in relation to the organ's expression pedal. To adjust the headphone volume, advance to the "HEADPHONE MASTER" window function (*see Section A-2*).

```
HEADPHONE MASTER  
GAIN: -10dB
```

To change the Headphone Master Gain setting, press the **CURSOR** button on the Console Controller until the cursor is positioned on the Gain setting value. Turn the **ROTARY DIAL** on the Console Controller to change the gain setting. Gain adjustment range is from (off) or minus 35dB to +6db. Minus 35db is the least amount of gain while +6dB is the most or maximum amount of gain.

```
HEADPHONE MASTER  
GAIN: -35dB
```

```
HEADPHONE MASTER  
GAIN: 6dB
```

C. MIDI FUNCTIONS

This section explains the MIDI capabilities of your Allen Organ. Knowledge of this section is **not** required for everyday use of the organ, normal service playing, or use of Allen SmartMIDI™ devices. This information's usefulness will ultimately be determined by your needs, along with the type and capabilities of any external MIDI devices you choose to use--e.g., sequencers, voice/sound modules and external MIDI keyboards. The MIDI topics covered by this manual are limited in scope. You need to understand the terms MIDI IN, OUT and THRU and their basic functions. To increase your understanding of MIDI you will need to read books that describe how to use MIDI.

Note: You must also consult the owner's manual that covers the external MIDI device(s) you are using for more details of their operation.

1. Standard MIDI Channel Assignments

These are the Allen Organs' standard MIDI channels settings:

Historique III™	
Channel	Organ Division
1	= Swell
2	= Great
3	= Pedal
4	= Positiv
8	= General

Note: The MIDI Base Channel always resets to Channel 1 whenever the organ is turned on (*see section C-5*).

2. Selecting Program Change Modes, Viewing Program Numbers or General MIDI Sound Names

Program change modes establish how MIDI program changes will be sent from the organ when a piston is pressed and what the resulting display will be in the Console Controller window. Once a particular program change mode is selected, the organ will retain this same program change mode (even when the organ is turned off) until a new program change mode is selected. These three mode options determine how the organ sends program change information to MIDI devices.

Selecting a Program Change Mode

Advance to the 'PROG CHG' window function (*see Section A-2*). It will display:

```
PROG CHG:  USER
DISPLAY:  NUMBERS
```

Press the **CURSOR** button until the cursor is positioned on the Program Change mode value. Turn the **ROTARY DIAL** to change and select either "Preset", "User" or "No" modes.

```
PROG CHG:  PRESET
DISPLAY:  NUMBERS
```

Important! You must understand how to operate and when to use each of these modes before you change them!

PRESET Mode: This mode causes the organ to send a program change number equal to the piston number that is pressed. General Pistons will send program changes 1-5 on MIDI Channel 8, the organ's General Piston control the channel.

USER Mode: In this mode the organ is capable of sending any program change number on any piston that will select voices, change banks, or change program or "patch" numbers on another MIDI device. Any MIDI program change number from 1 through 128 can be assigned to any General Piston (blank or no digit may also be selected). Any MIDI bank switch number between 0 and 127 can also be assigned. As in PRESET mode, General Pistons will send program change information on MIDI Channel 8.

NO Mode: With this mode selected, NO information is transmitted or received. This mode cancels transmission and reception of all program change information.

3. General MIDI Sound Names or Program Numbers

The Console Controller™ window can display MIDI program changes as either MIDI program numbers or as General MIDI sound names. Press the **CURSOR** button until the flashing cursor is positioned on the Display mode value. Turn the **ROTARY DIAL** to change and select one of the two modes.

General MIDI Sound Names

With General MIDI mode selected, the 'PROG CHG' window will display:

```
PROG CHG:  USER
DISPLAY: GEN MIDI
```

Make sure the word USER is selected as the Program Change mode and that GEN MIDI has been selected following the word DISPLAY. You must advance to the next window function then press a piston to view the sound names for any General MIDI device. The next window will display:

```
MIDI PROG CHANGE
```

When you press a General piston, the Console Controller™ window will display the General MIDI sound name which corresponds to the MIDI program change selected. For example, press General Piston 1. The Console Controller™ will display the MIDI program change name assigned to that piston.

```
GEN 1  BANK  0
P:Ac Grand Piano
```

Note: In some cases, the General MIDI sound name may be abbreviated in the Console Controller window.

You can change either the Bank value or Program Change name at any time by pressing the **CURSOR** button until the cursor is positioned on the value you wish to change. Turn the **ROTARY DIAL** to change the selected value. *Section C-4* explains this procedure in more detail.

1. Any Bank value between 0 and 127 may be selected.
2. Any General MIDI sound name may be selected and assigned to a piston. See *Section E-4* later in this manual for a list of available General MIDI sound names.

Program Numbers:

With **NUMBERS** selected as the display mode, the 'MIDI PROG CHANGE' window function will display:

```
GEN 1  BANK  0
P:XXX
```

With **PRESET** selected as the program change mode, press a General piston. The Console Controller™ window will display the same MIDI program change number as the associated piston pressed. For example, pressing General Piston 1 will display:

```
GEN 1  BANK  0
P:  1
```

The MIDI program change number will be displayed in **PRESET** mode, no matter if **NUMBERS** or **GEN MIDI** is displayed. You must select **USER** mode to view the **GENERAL MIDI** sound names. You must also select **USER** mode to assign MIDI program change numbers larger than 5 (the largest number of the General pistons).

With **USER** selected as the program change mode, along with **NUMBERS** as the display mode, you will be able to assign “- - -” (OFF) or any program change number from 1 through 128 to any General piston.

There may be a number or “- - -” following the “**P:**”. This “**P:**” represents the Program Change Number and does not stand for **PRESET** in this window. If there is “- - -” following “**P:**” this means that the “**ZERO**” Program Change Number will be sent from the associated piston.

To change the program change numbers, press the **CURSOR** button until the flashing cursor is positioned on the program change number value. Turn the **ROTARY DIAL** to change the program number value. *Section C-4* explains this procedure in more detail.

Note: The Allen Organ uses MIDI Program Change Zero as a message for "MIDI OFF."

Important! MIDI Program Change 1 corresponds to the General MIDI sound "Acoustic Grand Piano." Some MIDI devices do not use MIDI Program Change zero as MIDI OFF. Consequently, Program Change Zero, (“- - -“ *in the window*) when sent from the organ, will correspond to Program Change 1 on those MIDI devices, MIDI Program Change 1 will correspond to MIDI Program Change 2, etc. You must understand how the connected MIDI device responds to MIDI program changes to know which program change numbers to assign to a General piston to be able to get a selected voice on a given MIDI device. Refer to the specific MIDI device’s owner’s manual for more information about MIDI program change response.

4. Assigning MIDI Program Changes to Organ Pistons

This function allows the organist to select any voice on an external MIDI device by pressing any General piston on the organ. The "USER" program change mode must be selected (*See Section C-2*). Advance to the 'MIDI PROG CHANGE' window function (*see Section A-2*).

```
MIDI PROG CHANGE
```

For this example press the General Piston 2. The display will change to:

```
GEN 2    BANK  0  
P:  2
```

The LCD will display the piston pressed and the MIDI program number being transmitted by that piston. To change the value transmitted, press the **CURSOR** button until the cursor is positioned on the program change number value. Turn the **ROTARY DIAL** to change the program number value. Any program number of (1-128) may be selected. (*See Section C1*).

```
GEN 2    BANK  0  
P: 128
```

Note: Once a MIDI program change number is assigned to a piston, that program number will remain assigned to that piston even if the organ has been turned off.

Important! Once MIDI program change programming is complete the user must exit the piston programming window function, by using the **SET** and **CANCEL** pistons (*see Section A-2*), for any changes to take effect.

5. MIDI Bank Selecting

Many MIDI devices permit access to a variety of sounds in addition to the General MIDI sounds. Normally these additional sounds are stored in groups called BANKS. A BANK in MIDI terminology means a group of voices or sounds. There are two levels of banks. One level offers two choices, High Bank and Low Bank. Each of these, High Bank and Low Bank, has as sub-groups other level of banks, BANK Numbers.

MIDI devices can have as many as 128 sounds/voices per BANK Number. There can also be 128 available BANK Numbers (Ø through 127). With 128 BANK Numbers, each could contain up to 128 voices/sounds, for a total of 16,384 sounds. For an easier explanation, think of these BANK Numbers as floors or stories in a tall building. Each floor would contain 128 rooms and each room could then contain 128 voices.

There are MIDI devices that are High Bank and Low Bank compatible. It would be possible for these MIDI devices to have as many as (128 X 128 X 2 = 32,768 voices/sounds) 128 voices/sounds in each of the 128 BANK Numbers, in each of the High and Low Banks. Most MIDI devices do not use all of the locations available. It would be very expensive as well as difficult to remember the address for each sound location. There are also MIDI devices that offer only General MIDI sounds/voices. These General MIDI devices may operate using High Bank or Low Bank, but only the sub-group Ø Bank Number is used to store the 128 General MIDI sound settings. Allen Organs are able to access any of the Banks and therefore can communicate with all MIDI devices.

Note: You MUST know the capabilities of, and understand how to operate the MIDI device you intend to use with the organ!

Selecting High Bank or Low Bank:

Advance to the 'MIDI BASE CHANNEL' window function (*see Section A-2*).

```
MIDI BASE CH: 1
BANK: Low
```

Press the **CURSOR** button until the cursor is positioned on the BANK value. Turn the **ROTARY DIAL** to select either HIGH or LOW Bank priority.

Selecting MIDI Bank Numbers:

Bank Numbers are assignable in the same way that MIDI Program Numbers are (*See Section C-3*). You MUST have USER mode selected before assigning Bank numbers! Advance to the 'MIDI PROG CHANGE' window function (*see Section A-2*).

```
MIDI PROG CHANGE
```

For this example press the General piston #1. The display will change to:

```
GEN 1      BANK  Ø
P:  1
```

The window will display the piston pressed, the MIDI BANK Number, and the program number being sent by that piston. Press the **CURSOR** button until the cursor is positioned on the MIDI Bank number value. Turn the **ROTARY DIAL** to change the MIDI BANK number value.

Note: Refer to the Bank selection/program number chart in the owner's manual for the external MIDI device you are using to be sure you are using a valid Bank number value.

Note: Once you have assigned a MIDI BANK Number to a piston, that number will remain assigned to that piston even if the organ has been turned off.

Important! Once MIDI Bank change programming is complete the user must exit the piston programming window function, by using the **SET** and **CANCEL** pistons (*see Section A-2*), for any changes to take effect.

6. Changing the MIDI Base Channel

This function allows you to change the setting of the MIDI Base Channel. The Base Channel is a reference point to establish the positioning of the other 15 MIDI channels on the organ. On Allen Organs, the Base Channel equals the Swell Division's channel of transmission (i.e., if the Base Channel = 1, then the Swell Channel = 1, if the Base Channel = 2, then the Swell Channel = 2, etc.). Moving the Base Channel allows you to shift the organ's range of MIDI channels, this is helpful when reassigning an external MIDI device from one organ division to another.

Important! The Base Channel always resets to Channel 1 whenever the organ is turned on.

Advance to the 'MIDI BASE CH' window function (*see Section A-2*).

```
MIDI BASE CH:  1
BANK: Low
```

Press the **CURSOR** button until the cursor is positioned on the MIDI Base Channel value. Turn the **ROTARY DIAL** to change the MIDI Base Channel value. All functions associated with a particular division will transmit and receive on its assigned channel. For example, MIDI Channel 1 is normally assigned to the Swell Division and the Swell Manual. Therefore, keying velocity or on/off messages will be transmitted and received on MIDI Channel 1 (*See Section C-1 for Allen MIDI Channel Assignments*).

If the Base Channel is set to 2, all of the channels will shift higher by one. Now; Swell = 2, Great = 3, Pedal = 4 and the General Pistons = 9. **Note:** MIDI Channel numbers will wrap, i.e. channel numbers go only to 16 and will then repeat to 1.

7. MIDI Expression Settings

Advance to the 'MIDI EXPRESSION' window function (*see Section A-2*).

```
MIDI EXPRESSION
POLY-VOLUME
```

There are four modes for transmitting expression data via MIDI. To select an expression mode, press the **CURSOR** button until the cursor is positioned on the expression setting value (line 2) of the display. Turn the **ROTARY DIAL** to select one of the four different expression modes.

Note: The default expression mode setting is always POLY-VOLUME.

POLY-VOLUME — This is the normal expression mode setting where the expression data is distributed among the appropriate MIDI channels. This is the proper mode to use when recording to, or playing back from, a sequencer.

POLY-VELOCITY — This setting should be selected if you are using a percussion-type voice from a sound module or an external MIDI keyboard. For example, if a digital piano sound were played from the organ keyboard through MIDI Channel 1, the piano could be made to sound more realistic. By opening the Swell expression shoe, the piano strings would appear to be struck harder than when the Swell pedal was in the closed position.

Note: This mode setting should only be used if your Allen Organ does not contain velocity sensitive keying.

Note: In POLY-VELOCITY mode, all expression information is sent in key velocity form. Changes in velocity will occur only when a new key is struck. Consequently, if you change the position of the Swell pedal after a key is struck there will be no change in velocity until a new key is struck. Use this mode only when a velocity-sensitive external MIDI device is connected. If this mode is selected when recording to a sequencer, the expression on the organ will not function when playing back from the sequencer.

SWELL-VOLUME — This setting causes MIDI expression data to be sent only on the Swell MIDI channel. Some early sequencers can only interpret one volume message.

NO EXPRESSION — No MIDI expression (volume) data sent.

8. MIDI Sustain Kick Switch (optional)

A lever located to the left of the expression shoe and controlled by the organist's foot, operates MIDI sustain. This function can be assigned to any one of or all of the instrument's manuals. Advance to the 'MIDI SUSTAIN' window function (*see Section A-2*).

```
MIDI SUSTAIN
GT = OFF
```

To select an organ keyboard (manual), press the **CURSOR** button until the cursor is positioned on the manual abbreviation. Turn the **ROTARY DIAL** to select an organ keyboard. Then, to turn the MIDI Sustain function on/off on the selected manual, press the **CURSOR** button until the cursor is positioned on the MIDI Sustain value. Turn the **ROTARY DIAL** to turn the selected manual **ON/OFF**. **OFF** will not allow MIDI Sustain messages to be transmitted, **ON** will allow MIDI sustain messages to be transmitted on a given keyboard (manual) or MIDI channel. For example, when a **PIANO** voice in an external MIDI device (voice module) is selected and the MIDI sustain for that given MIDI channel (division) is turned **ON**, and the foot controlled sustain lever is actuated, the piano sound will slowly decay.

9. Organ Local Off

Organ Local Off is a function that allows the user to “virtually” disconnect the organ's keyboards, pedalboard and pistons from the organ's tone generation and capture system. In essence, the organ is transformed into a sophisticated multi-manual MIDI controller. To enable/disable the Organ Local Off function, advance to the 'ORGAN LOCAL OFF' window function (*see Section A-2*).

```
ORGAN LOCAL OFF
= DISABLED
```

```
ORGAN LOCAL OFF
= ENABLED
```

To enable/disable the Organ Local Off function, press the **CURSOR** button until the flashing cursor is positioned on the Local Off control value. Turn the **ROTARY DIAL** to change the enable/disable value.

Note: When Organ Local Off is enabled, the MIDI stops do not need to be on to play the external MIDI device(s).

10. Transferring and Saving Capture Memory Data to a Sequencer

CAPTURE MEMORY refers to all of the piston registrations on all available memories, piston configuration settings, plus all MIDI settings as well as MIDI program changes. With this operation, the organist can copy and save all of this stored information to a digital MIDI sequencer.

Advance to the 'CAPTURE MEMORY SAVE' window function (*see Section A-2*).

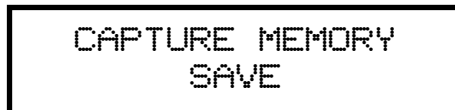

Set your sequencer to the record mode and begin recording as you normally would. Press and hold the **MEMORY** button in the Console Controller™. While holding **MEMORY**, press General Pistons 2-5-5 in sequence. The Capture Memory information will be transmitted to the sequencer. During the memory data transfer process the window will display:

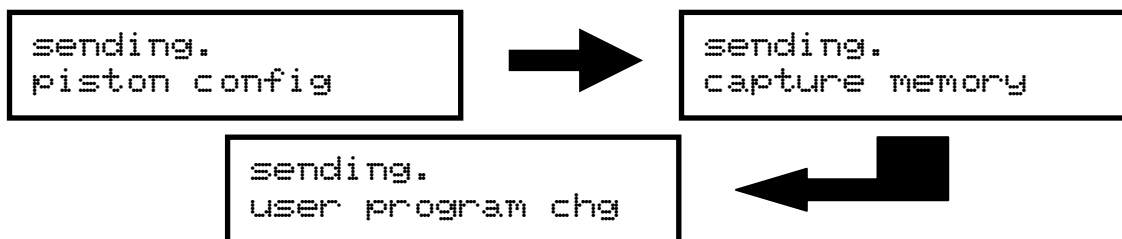
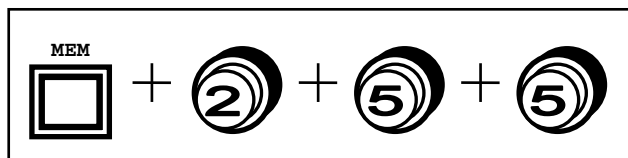

The 'dot' behind the word 'SENDING' on line one of the display will move as data is transmitted.

Note: This procedure can take an extended period of time, so please be patient. Once completed, a copy of the Capture Memory information will exist in the sequencer and the original information will be retained in the Console Controller™ memory.

11. Return Capture Memory Data from a Sequencer to the Organ

To replace previously recorded Capture Memory information into the organ from your sequencer, simply press "Play" on the sequencer and the recorded capture data will automatically be transmitted to the organ. You must have a MIDI cable connected from the OUT port of the sequencer to the IN port of the Allen Organ. It does not matter what window function the Console Controller displays.

Note: The Capture Memories must be unlocked (*see section A-6*) before you press "Play" on the sequencer, allowing the organ's available memories to receive capture information. It is a good idea to first save whatever is stored in the organ's memory because it will be erased by this procedure.

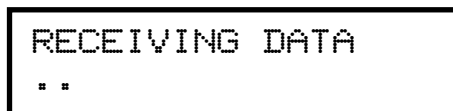

Note: The 'dot' on line two of the display will move as data is received.

12. Transmission/Reception of Individual Stop Data

This function allows the organist to turn on/off the transmission and reception of individual stop data, known in MIDI terminology as "Non-Registered Parameters". In some cases individual stop data (on/off) from the organ may conflict with data from an external MIDI device. When this occurs, select the "OFF" position.

Note: Piston changes will still be transmitted and received, because they are classified as program changes.

Advance to the 'TRANSMIT / RECEIVE STOPS' window function:



```
TRANSMIT/RECEIVE
STOPS ON
```

To change the on/off status of the Transmit/Receive Stops function, press the **CURSOR** button until the cursor is positioned on the status control value. Turn the **ROTARY DIAL** to change the transmit/receive status on or off.

D. QUICK REFERENCE GUIDE

1. Basic Operations Review

a. Advancing Through the Windows:

Use the **ROTARY DIAL** in the Console Controller.

b. Return to the Main Window function from ANY other window function:

Hold **SET**, press **CANCEL**, release both or use the **ROTARY DIAL** in the Console Controller.

c. Setting Pistons:

Main Window. Select desired registration. Hold **SET** and press piston to remember registration.

d. Select Memory and Lock It:

Main Window. Select desired memory using **CURSOR** button and **ROTARY DIAL**. Press and hold **MEMORY** button, enter three-digit code on general pistons, release **MEMORY**, "L" will appear next to capture memory number in display.

e. Unlock a Memory:

Repeat d. above. "L" will disappear.

f. Unlock All Memories Without Code:

Advance to display "Unlock All Capture Memories". Press and hold **MEMORY**, press General Pistons 2-5-5, release **MEMORY**. Display returns to *Main Window* function.

g. Self-Check Capture and Stop Action:

Advance to display: "Self-Check". Turn **ROTARY DIAL** to activate/de-activate Self-Check or to de-activate, press and hold **SET**, press **CANCEL**, and then release both.

2. Advanced Operations Review

a. Reconfiguring Pistons:

Advance to display: "Configure Pistons". Select the desired stops. Press and hold **SET**, and then press the desired piston. To return to the *Main Window*, (press and hold **SET**, press **CANCEL** and then release both). Set new registrations (*see section E-1, c.*).

b. Restore Factory Settings:

Advance to display: "Re-Initialize Piston Configuration". Use **CURSOR** button and **ROTARY DIAL** to select the settings you want to restore. Press and hold **MEMORY**, press General Pistons 2-5-5.

E. MIDI GUIDE

1. MIDI for Organists

The term MIDI is an acronym for Musical Instrument Digital Interface. MIDI has been adopted by the music industry as a standard means of communication between digital musical devices enabling devices of different types and manufacturers to communicate. MIDI by itself will not make a sound. It is not necessary to understand all of the technical aspects of MIDI in order to take advantage of the benefits it offers. It is important to explore the potential MIDI holds for musicians, as well as the various MIDI applications available today.

Types of MIDI Devices

MIDI devices fall into two categories.

1. The first category consists of musical instruments such as organs and synthesizers that transmit and receive MIDI data.
2. The second category includes controllers and processors that, as their name implies, can transmit, receive or manipulate MIDI data, but do not necessarily produce sound themselves. Sequencers, which are MIDI recording devices, fall into this category. Although the technical nature of their recording and editing processes differs from those of a tape recorder, many operate in similar fashion. Most are equipped with record, playback, fast forward and reverse controls that function in the same way as their tape recorder counterparts.

Types of MIDI Data

There are several types of MIDI messages that can be sent from one device to another. The most common is keying information, allowing one device to sense which keys have been played on another device. This means an organ equipped with MIDI can send information to other MIDI devices, e.g., synthesizers or sequencers, and can play those devices simultaneously or record information to be played back later.

Allen Organs incorporate an advanced MIDI system allowing the transmission and reception of all types of MIDI information (velocity keying, volume change, sustain, registrations and much more). It is even possible to control several devices from one manual simultaneously, or control a different device from each manual of the console.

MIDI as a Practice Tool

For the organist/choir director, the MIDI organ console and sequencer are valuable rehearsal tools for both choral and organ works. Anthem accompaniments may be recorded in advance and played back by the sequencer during choir rehearsal. The director, freed from the role of accompanist, can focus entirely on directing the choir. The sequencer can play the music back at a slower tempo without affecting pitch, or at a lower pitch without affecting tempo, features that are useful in rehearsing difficult choral passages.

If the sequencer allows multi-tracking, each vocal section's part may be recorded on a different track, and then played back individually, or in any combination, for more flexibility. Multi-tracking can also be used in teaching and learning new organ works. The teacher may record each hand or pedal part on a different track, allowing the student to "mute" or turn off any part being practiced while still being able to hear the sequencer play the rest of the composition. The student's ability to hear the piece in its entirety from the earliest stage of learning a composition, and to become aware of the interrelationship of its voices, is especially valuable in learning contrapuntal works.

MIDI as a Registration Tool

In some churches and auditoriums it is difficult to judge the effectiveness of a registration from the organ console. Due to the acoustics of the room, or positioning of the console, the sound of the instrument may be different when listened to from the congregation's or audience's vantage point. MIDI allows the organist to evaluate registrations by recording the music using a sequencer, and then listening from different locations in the room during the music's playback.

Other MIDI Uses

MIDI has created new possibilities for the organist. The ability of the organ console to control external keyboards or sound modules puts an ever-increasing array of non-traditional sounds at the organist's fingertips. A superior degree of control is made possible by the flexibility of an organ console. The ability to record MIDI data using a sequencer opens a variety of new possibilities during practice and performance situations.

Computer software programs are also available that allow musicians to play MIDI devices connected to a computer, and have their performance printed as conventional five-line musical notation. Because MIDI is an industry-wide standard, today's MIDI instruments will be compatible with tomorrow's MIDI innovations.

2. Allen's Exclusive MIDI System

Allen Organs feature an advanced MIDI system with increased flexibility. This system provides a comprehensive interface between MIDI sound modules, such as the Allen Ensemble™, and digital sequencers such as the Allen MIDI Assistant™. Two MIDI Out ports, one switched and one unswitched, allow unprecedented control over external MIDI devices attached to the organ.

Under normal circumstances, MIDI sound modules should be connected to the switched MIDI port labeled MIDI OUT 2. Doing so allows the organist to disable the sending of MIDI keying data from the organ to the sound module. Devices such as MIDI sequencers should be connected to the unswitched MIDI port labeled MIDI OUT 1, eliminating the necessity of having to draw the MIDI stop controls before recording a digital sequence. The drawing below illustrates the proper procedure for connecting the Allen Ensemble™ and Allen MIDI Assistant™ to an Allen Organ.

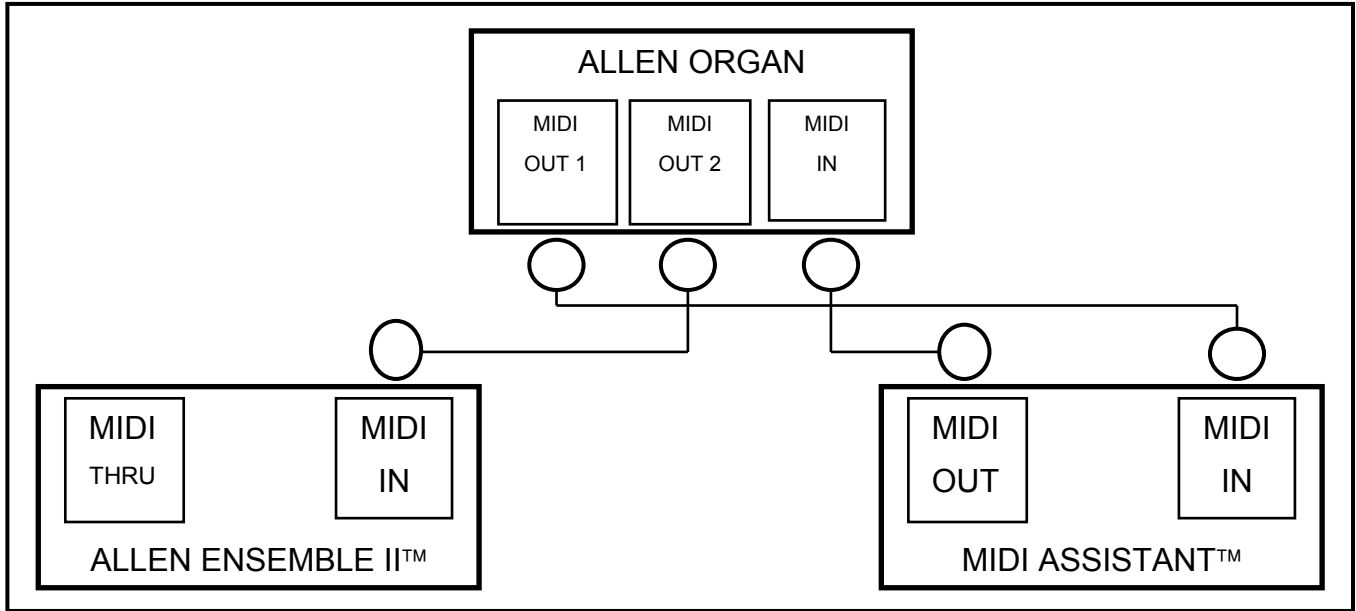

3. MIDI Transmission Channels

MIDI information may be transmitted on several different channels simultaneously. This allows many channels of information to be sent through one cable and used independently from one another, similar to the way many television broadcasts can be sent through one cable. In order to receive the intended information, a MIDI device must be tuned to the same channel as the device that is sending the information.

Your Allen Organ transmits MIDI information on several channels. When external MIDI devices are connected to the organ, it is important to make sure that the devices' channels of transmission and reception match the MIDI channels of the Allen Organ divisions to which they are assigned.

MIDI Program Change Messages are transmitted from the organ's General Pistons on MIDI Channel 8. These program change messages can be used to change the settings of MIDI sound modules or synthesizers that are connected to the organ. Please consult the owner's manual of your MIDI device(s) for more information on how MIDI Program Change Messages are handled by that particular device.

In addition to keying and divisional registration information, MIDI Volume Messages are sent on the individual MIDI channels for each division of the organ. These volume messages are controlled by the expression shoe. In this manner, the volume of connected MIDI devices may be controlled.

Please consult the owner's manual of your MIDI device(s) for more information on how MIDI Volume information is handled by that device. If any external MIDI device is used to transmit information to the Allen organ, the same assignment of MIDI channels must be used as described elsewhere in this manual.

4. GENERAL MIDI SOUND SET

1. Acoustic Grand Piano
2. Bright Acoustic Piano
3. Electric Grand Piano
4. Honky-tonk Piano
5. Rhodes Piano
6. Chorused Piano
7. Harpsichord
8. Clavinet
9. Celesta
10. Glockenspiel
11. Music Box
12. Vibraphone
13. Marimba
14. Xylophone
15. Tubular Bells
16. Dulcimer
17. Hammond Organ
18. Percussive Organ
19. Rock Organ
20. Church Organ
21. Reed Organ
22. Accordion
23. Harmonica
24. Tango Accordion
25. Acoustic Guitar (nylon)
26. Acoustic Guitar (steel)
27. Electric Guitar (jazz)
28. Electric Guitar (clean)
29. Electric Guitar (muted)
30. Overdriven Guitar
31. Distortion Guitar
32. Guitar Harmonics
33. Acoustic Bass
34. Electric Bass (finger)
35. Electric Bass (pick)
36. Fretless Bass
37. Slap Bass 1
38. Slap Bass 2
39. Synth Bass 1
40. Synth Bass 2
41. Violin
42. Viola
43. Cello
44. Contrabass
45. Tremolo Strings
46. Pizzicato Strings
47. Orchestral Harp
48. Timpani
49. String Ensemble 1
50. String Ensemble 2
51. SynthStrings 1
52. SynthStrings 2
53. Choir Aahs
54. Voice Oohs
55. Synth Voice
56. Orchestra Hit
57. Trumpet
58. Trombone
59. Tuba
60. Muted Trumpet
61. French Horn
62. Brass Section
63. Synth Brass 1
64. Synth Brass 2
65. Soprano Sax
66. Alto Sax
67. Tenor Sax
68. Baritone Sax
69. Oboe
70. English Horn
71. Bassoon
72. Clarinet
73. Piccolo
74. Flute
75. Recorder
76. Pan Flute
77. Bottle Blow
78. Shakuhachi
79. Whistle
80. Ocarina
81. Lead 1 (square)
82. Lead 2 (sawtooth)
83. Lead 3 (caliope lead)
84. Lead 4 (chiff lead)
85. Lead 5 (charang)
86. Lead 6 (voice)
87. Lead 7 (fifths)
88. Lead 8 (brass + lead)
89. Pad 1 (new age)
90. Pad 2 (warm)
91. Pad 3 (polysynth)
92. Pad 4 (choir)
93. Pad 5 (bowed)
94. Pad 6 (metallic)
95. Pad 7 (halo)
96. Pad 8 (sweep)
97. FX 1 (rain)
98. FX 2 (soundtrack)
99. FX 3 (crystal)
100. FX 4 (atmosphere)
101. FX 5 (brightness)
102. FX 6 (goblins)
103. FX 7 (echoes)
104. FX 8 (sci-fi)
105. Sitar
106. Banjo
107. Shamisen
108. Koto
109. Kalimba
110. Bagpipe
111. Fiddle
112. Shanai
113. Tinkle Bell
114. Agogo
115. Steel Drums
116. Woodblock
117. Taiko Drum
118. Melodic Tom
119. Synth Drum
120. Reverse Cymbal
121. Guitar Fret Noise
122. Breath Noise
123. Seashore
124. Bird Tweet
125. Telephone Ring
126. Helicopter
127. Applause
128. Gunshot